

lenovo[®]

Lenovo IdeaPad Flex 14/Flex 14D Flex 15/Flex 15D User Guide



Read the safety notices and important tips in the included manuals before using your computer.

ideapad

Notes

- Before using the product, be sure to read *Lenovo Safety and General Information Guide* first.
- Some instructions in this guide may assume that you are using Windows® 8. If you are using other Windows operating systems, some operations may be slightly different. If you are using other operating systems, some operations may not apply to you.
- The features described in this guide are common to most models. Some features may not be available on your computer and/or your computer may include features that are not described in this user guide.
- The illustrations used in this manual are for Lenovo IdeaPad Flex 14 unless otherwise stated.
- The illustrations in this manual may differ from the actual product. Please refer to the actual product.

Regulatory Notice

- For details, refer to **Guides & Manuals** at <http://support.lenovo.com>.

First Edition (July 2013)

© Copyright Lenovo 2013.

LIMITED AND RESTRICTED RIGHTS NOTICE: If data or software is delivered pursuant a General Services Administration "GSA" contract, use, reproduction, or disclosure is subject to restrictions set forth in Contract No. GS-35F-05925.

Contents

Chapter 1. Getting to know your computer	1
Top view	1
Left-side view	9
Right-side view	12
Front view	14
Bottom view	15
Chapter 2. Starting to use Windows 8	16
Configuring the operating system for the first time	16
Operating system interfaces	16
Charms and the charms bar	17
Putting the computer to sleep or shutting it down	19
Touch screen operation	21
Connecting to a wireless network	24
Help and support	25
Chapter 3. Lenovo OneKey Recovery system	26
Chapter 4. Troubleshooting	28
Frequently asked questions	28
Troubleshooting	31
Trademarks	35

Chapter 1. Getting to know your computer

■ ■ Top view

■ Flex 14/Flex 14D

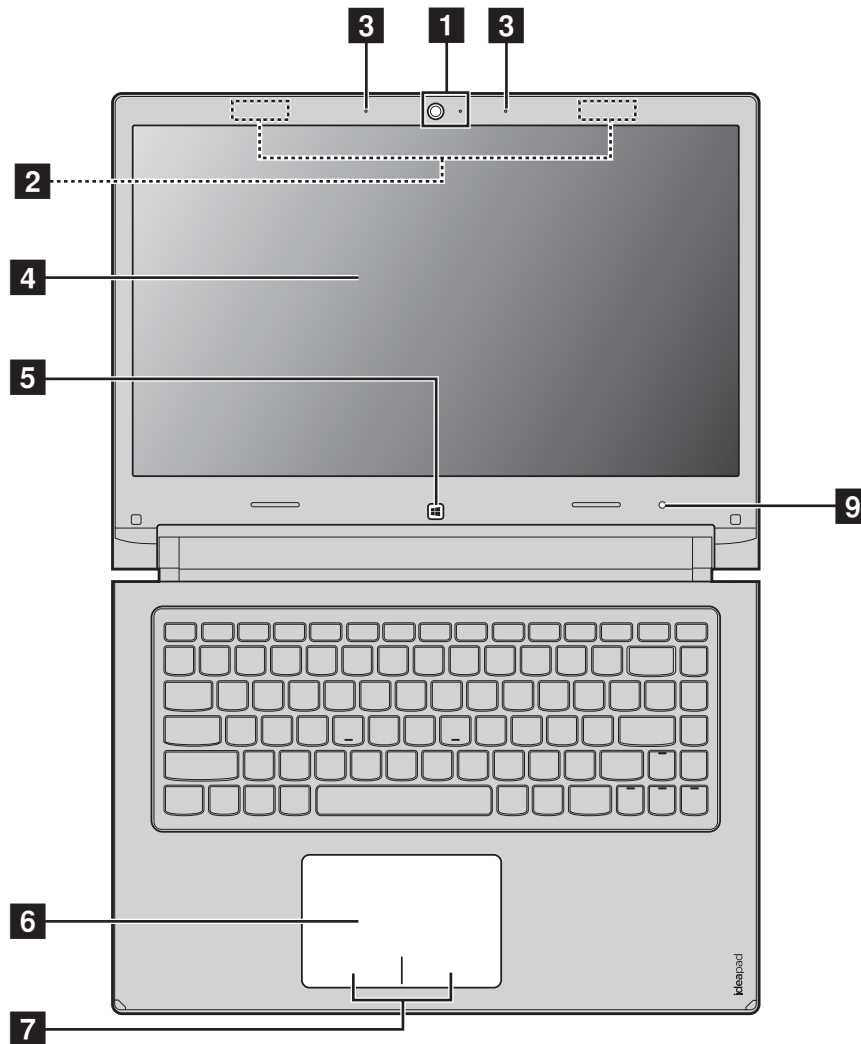

Chapter 1. Getting to know your computer

■ Flex 15/Flex 15D

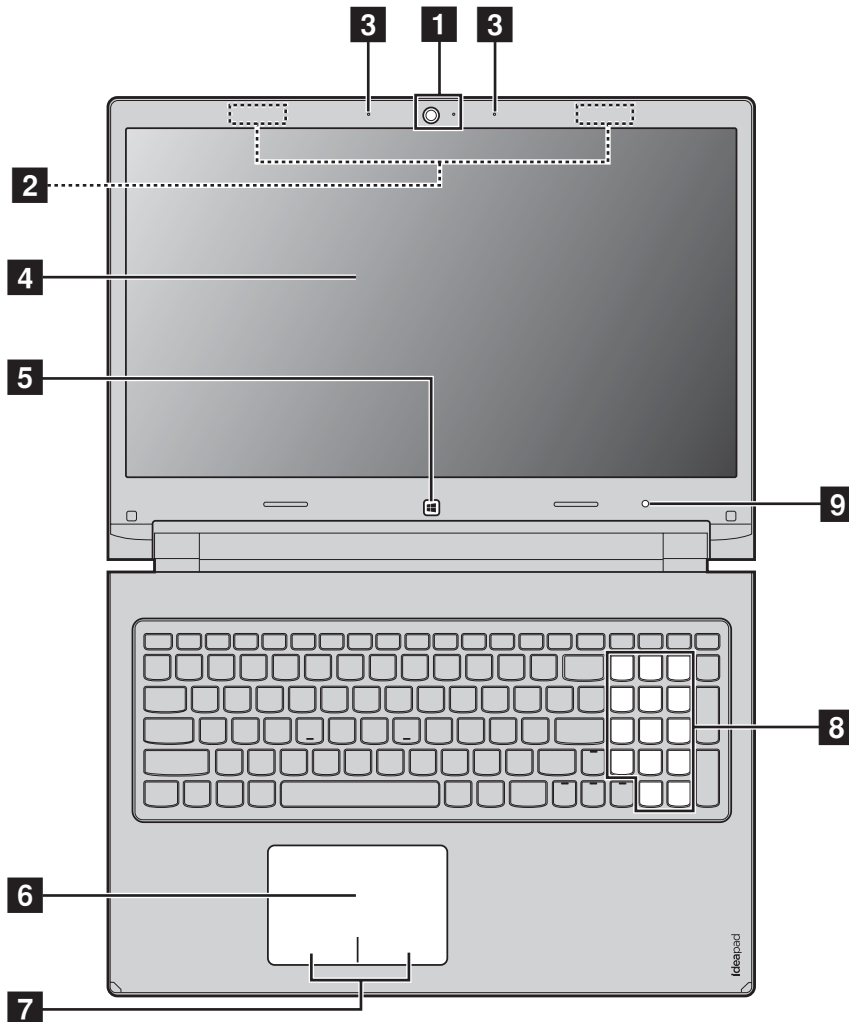

Note: The dashed areas indicate parts that are invisible from outside.

ⓘ Attention:

- Do *not* open the display panel beyond 300 degrees. When closing the display panel, be careful *not* to leave pens or any other objects in between the display panel and the keyboard. Otherwise, the display panel may be damaged.

Chapter 1. Getting to know your computer

- 1 Integrated camera** Use the camera for video communication.
- 2 Wireless antennas** Connect to the wireless adapter to receive and send wireless radio.
- 3 Built-in microphone** Captures sound which can be used for video conferencing, voice narration, or audio recording.
- 4 Display** Provides brilliant visual output.
- 5 Windows button (on select models)** Press this button to:
Toggle between the current view and the Start screen.
- 6 Touch pad** The Touch pad functions as a conventional mouse. To move the cursor on the screen, slide your fingertip over the pad in the direction in which you want the cursor to move.
- 7 Touch pad buttons** The functions of the left and right buttons correspond to those of the left and right buttons on a conventional mouse.

Note: You can enable or disable the Touch pad and the Touch pad buttons by pressing



- 8 Numeric keypad (Flex 15/Flex 15D)** For details, see “Using the keyboard” on page 4.
- 9 Light sensing hole (on select models)** This senses the ambient light. By default, the screen brightness changes automatically according to the ambient light.

Note: If you want to adjust the brightness of the screen manually, open the charms bar and select **Settings** → **Change PC settings** → **General** → **Screen** (Adjust my screen brightness automatically) and toggle the switch to Off.

Chapter 1. Getting to know your computer

■ Using the keyboard

Your computer has number keys and function keys and may also have a numeric keypad (Flex 15/Flex 15D only) incorporated into its standard keyboard.

Numeric keypad

Flex 15/Flex 15D

The keyboard has a separate numeric keypad. To enable or disable the numeric keypad, press the **Num Lock** key.

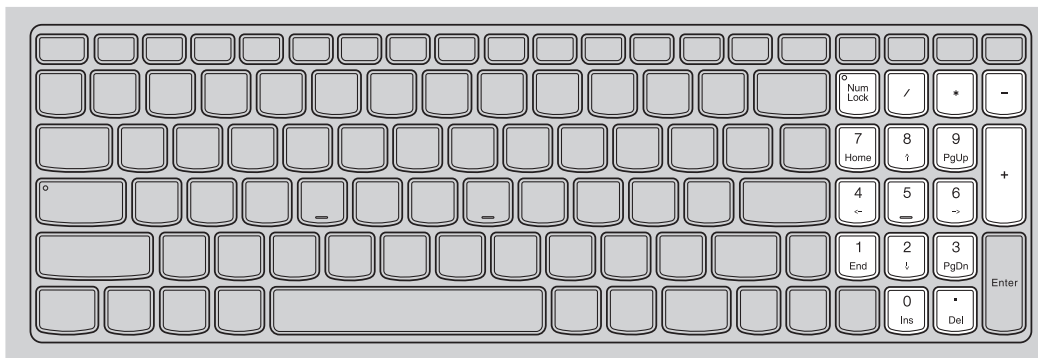

Chapter 1. Getting to know your computer

■ Hotkeys

You can access certain system settings quickly by pressing the appropriate hotkeys.

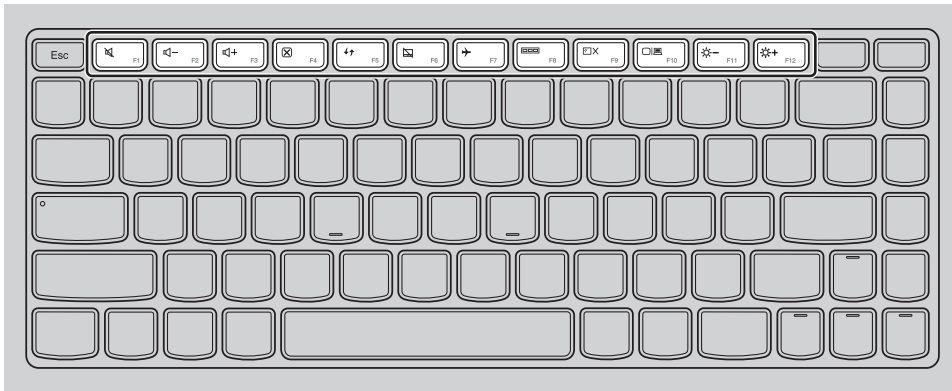



 : Mutes/unmutes the sound.

 : Enables/disables airplane mode.

 : Decreases the volume level.

 : Switches the active program.

 : Increases the volume level.

 : Turns on/off the backlight of the display.

 : Closes the currently active window.

 : Projects to a connected display.

 : Refreshes the desktop or the currently active window.

 : Decreases display brightness.

 : Enables/disables the touch pad and the touch pad buttons.

 : Increases display brightness.

Note: If you changed the **HotKey Mode** from **Enabled** to **Disabled** in the BIOS setup utility, you will need to press the Fn key in combination with the appropriate hotkey.

Chapter 1. Getting to know your computer

Function key combinations

Through the use of the function keys, you can change operational features instantly. To use this function, press and hold **Fn** **1**; then press one of the function keys **2**.

Flex 14/Flex 14D

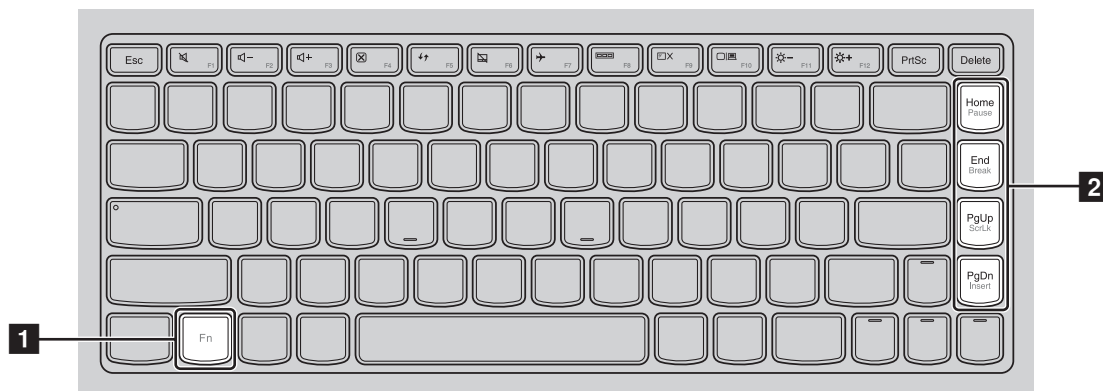

Flex 15/Flex 15D

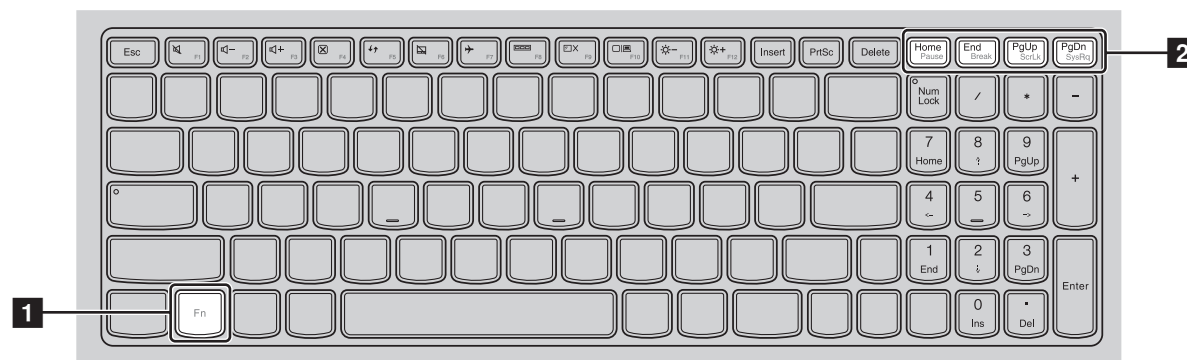

The following describes the features of each function key.

Fn + Home: Activate the pause function.

Fn + End: Activate the break function.

Fn + PgUp: Enable/Disable the scroll lock.

**Fn + PgDn (Flex 14/
Flex 14D):** Activate the insert function.

**Fn + PgDn (Flex 15/
Flex 15D):** Activate the system request.

Chapter 1. Getting to know your computer

■ Positioning the display panel

Notebook Mode



Suitable for tasks that require a keyboard and mouse (such as creating documents, writing e-mails, and so on).

Stand Mode (Theater Mode)



Suitable for tasks that require little or no touch (such as viewing photos or playing videos).

Chapter 1. Getting to know your computer

⦿ Attention:

- Do not open the display with too much force, otherwise the display panel or hinges may be damaged.

Notes:

- The keyboard and touch pad are automatically locked if the keyboard panel faces down.
- In the stand mode (theater mode), only the following buttons can be used:
 - Windows button
 - Volume Up button
 - Volume Down button
 - Power button
 - Novo button

● ● Left-side view

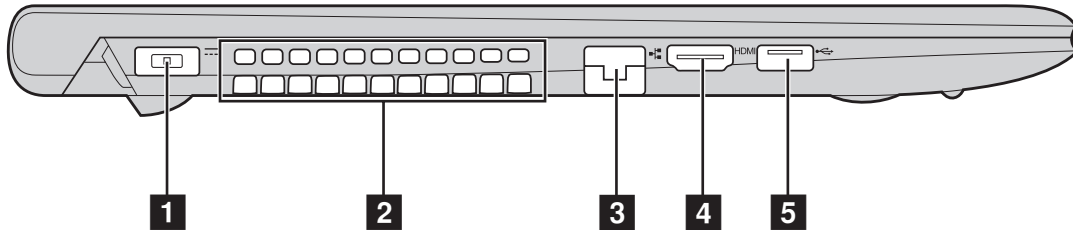

1 AC power adapter jack Connects the AC power adapter.

2 Ventilation slots Dissipate internal heat.

ⓘ **Attention:**

- Make sure that none of the ventilation slots are blocked or else overheating of the computer may occur.

3 RJ-45 port Connects the computer to an Ethernet network.

4 HDMI port Connects to devices with HDMI input such as a TV or a display.

5 USB 3.0 port Connects to USB devices.

Note: For details, see “Connecting USB devices” on page 10.

Chapter 1. Getting to know your computer

■ Connecting USB devices

You can connect a USB device to your computer by inserting its USB plug (Type A) into the USB port on your computer.

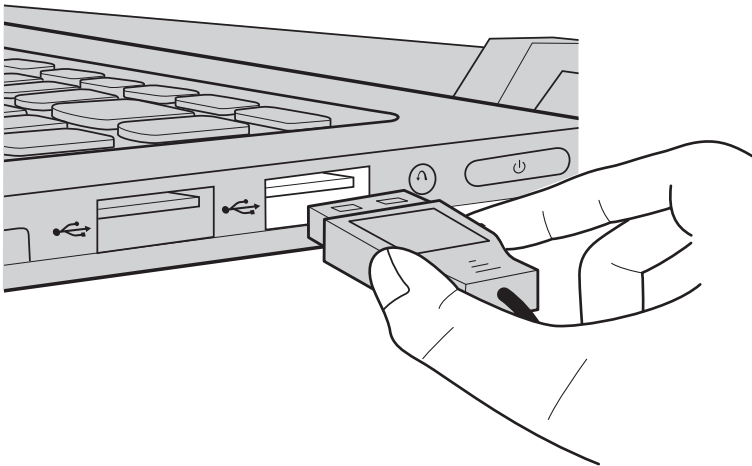

The first time you plug a USB device into a particular USB port on your computer, Windows automatically installs a driver for that device. After the driver is installed, you can disconnect and reconnect the device without performing any additional steps.

Note: Typically, Windows detects a new device after connecting it, and then installs the driver automatically. However, some devices may require you to install the driver before connecting. Check the documentation provided by the device's manufacturer before connecting the device.

Before disconnecting a USB storage device, make sure your computer has finished transferring data by that device. Click the **Safely Remove Hardware and Eject Media** icon in the notification area of the Windows desktop screen to remove the device before disconnecting.

Notes:

- If your USB device uses a power cord, connect the device to a power source before connecting it. Otherwise, the device may not be recognized.
- When in sleep mode, you can only use keyboard instead of mouse to wake up the computer.

Chapter 1. Getting to know your computer

■ Connecting network cables

To insert a network cable, do the following:

- ❶ Hold one connector of the network cable to press the RJ-45 cover down gently **1**.
- ❷ Insert the connector into the RJ-45 port **2**.

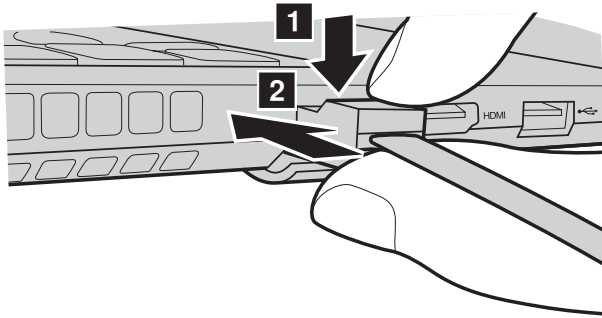

■ Software configuration

Consult your Internet Service Provider (ISP) for details on how to configure your computer.

Chapter 1. Getting to know your computer

Right-side view

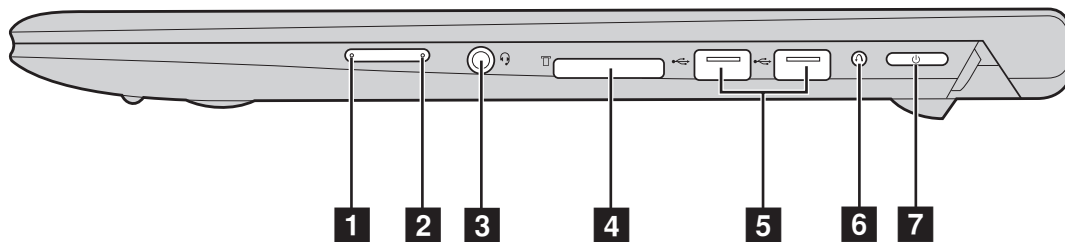

1 Volume up button Increases volume level.

2 Volume down button Decreases volume level.

3 Combo audio jack Connects to headsets.

Notes:

- The combo audio jack does not support conventional microphones.
- The recording function may not be supported if third-party headphones or headsets are connected, due to different industry standards.

4 Memory card slot Insert memory cards (not supplied) here. For details, see “Using memory cards (not supplied)” on page 13.

5 USB ports Connect to USB devices. For details, see “Connecting USB devices” on page 10.

6 Novo button When the computer is off, press this button to start the Lenovo OneKey Recovery system or the BIOS setup utility, or to enter the boot menu.

Note: For details, see “Chapter 3. Lenovo OneKey Recovery system” on page 26.

7 Power button Press this button to turn on the computer.

■ Using memory cards (not supplied)

Your computer supports the following types of memory card:

- Secure Digital (SD) card
- MultiMediaCard (MMC)

⦿ Attention:

- Insert *only* one card in the slot at a time.
- This card reader does not support SDIO devices (e.g., SDIO Bluetooth, etc.).

Inserting a memory card

Slide a memory card in until it clicks into place.

Note: If a dummy card is shipped with the computer, push the dummy card and then remove it before inserting a memory card.

Removing a memory card

Gently pull the memory card out of the memory card slot.

⦿ Attention:

- Before removing a memory card, disable it through **Safely Remove Hardware and Eject Media** to avoid data corruption.

Chapter 1. Getting to know your computer

■ ■ Front view

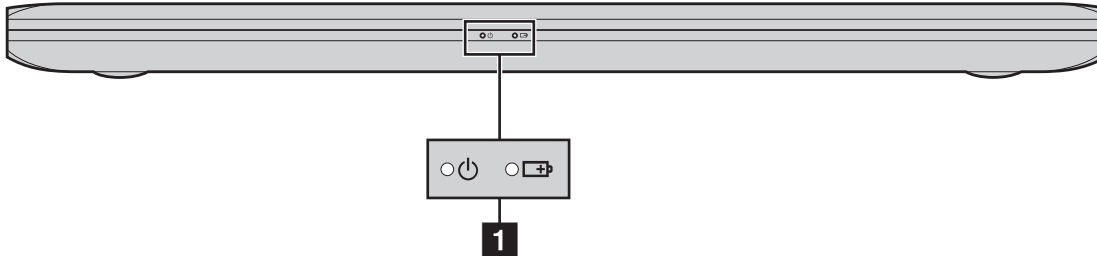

1 Power indicator

2 Battery indicator

Symbol	Indicator status	Meaning
	On (solid white)	The computer is powered on.
	Blinking	The computer is in sleep mode.
	Off	The computer is powered off.
	On (solid white)	The battery has more than 20% charge.
	Solid amber	The battery has between 5% and 20% charge.
	Fast blinking amber	There is a problem with the battery or the battery connection.
	Slow blinking amber	The battery is being charged. When battery charge reaches 20%, the blinking color changes to white.
	Slow blinking white	The battery has between 20% and 80% charge and is still charging. When the battery reaches 80% charge, the light will stop blinking, but charging will continue until the battery is fully charged.

■ ■ Bottom view

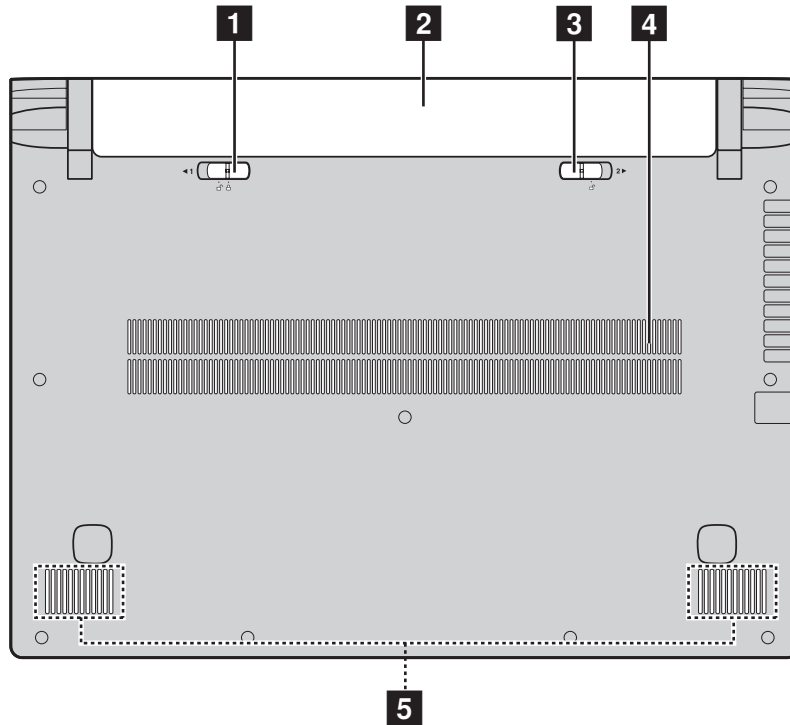

- | | | |
|----------|--------------------------------------|--|
| 1 | Battery latch - manual | Keeps the battery pack secured in place. |
| 2 | Battery pack | |
| 3 | Battery latch - spring loaded | Keeps the battery pack secured in place. |
| 4 | Ventilation slots | Allow air to enter the computer for cooling. |
| 5 | Speakers | Provide audio output. |

Chapter 2. Starting to use Windows 8

■ ■ Configuring the operating system for the first time

You need to configure the operating system when it is first used. The configuration process may include the procedures below:

- Accepting the end user license agreement
- Configuring the Internet connection
- Registering the operating system
- Creating a user account

■ ■ Operating system interfaces

Windows 8 comes with two main user interfaces: the Start screen and the Windows desktop.

To switch from the Start screen to the Windows desktop, do one of the following:

- Select the Desktop tile on the Start screen.
- Press the Windows button.
- Press the Windows key  + D.

To switch from the desktop to the Start screen, do one of the following:

- Select **Start**  from the charms bar.
- Move the cursor to the lower-left corner, then select the Start screen thumbnail when it is displayed.

Start screen

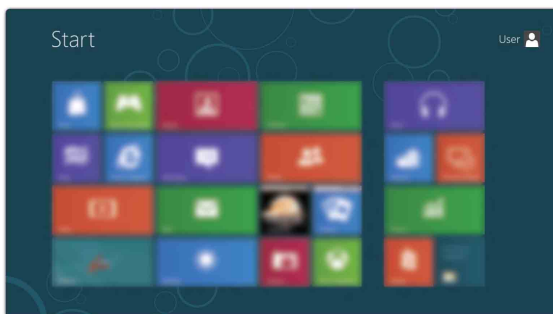

Desktop

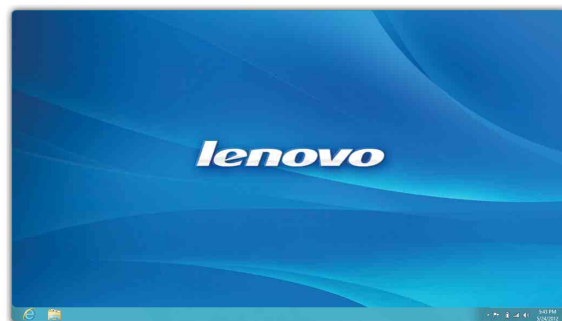

■ ■ Charms and the charms bar

Charms are navigation buttons that let you access basic tasks quickly. Charms include: Search, Share, Start, Devices, and Settings. The **charms bar** is the menu that contains the charms. To display the charms bar, do one of the following:

- Move the cursor to the upper-right or lower-right corner until the charms bar is displayed.
- Use one finger to swipe in from the right edge of the screen until the charms bar is displayed.
- Press the Windows key  + C.

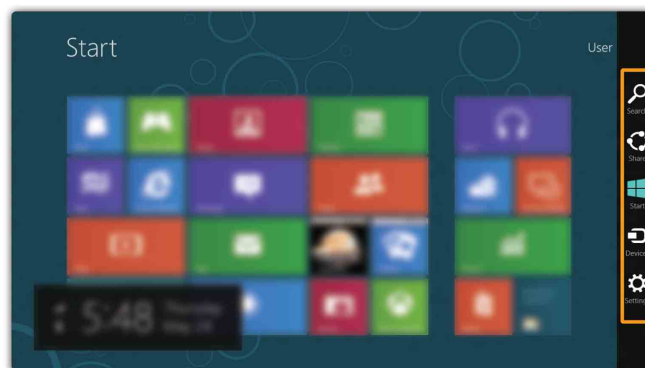

Search charm

The **Search** charm is a powerful new way to find what you are looking for, including apps, settings and files.

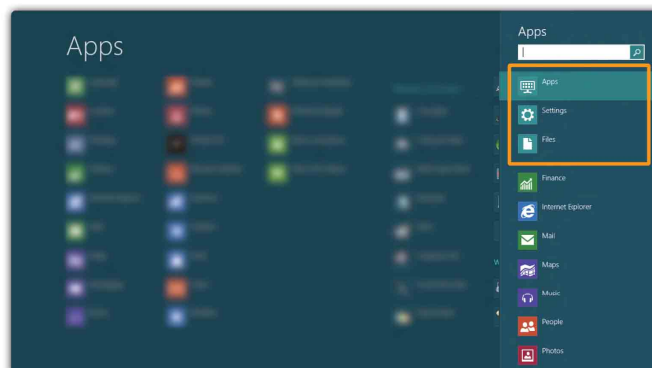

Chapter 2. Starting to use Windows 8

Share charm

The **Share** charm lets you send links, photos, and more to your friends and social networks without leaving the app you are in.

Start charm

The **Start** charm is a fast way to go to the Start screen.

Devices charm

The **Devices** charm allows you to connect or send files to connected external devices, including digital cameras, TVs, and printers.

Settings charm

The **Settings** charm lets you perform basic tasks, such as setting the volume or shutting down the computer. Also, you can get to the Control Panel through the **Settings** charm when on the Desktop screen.

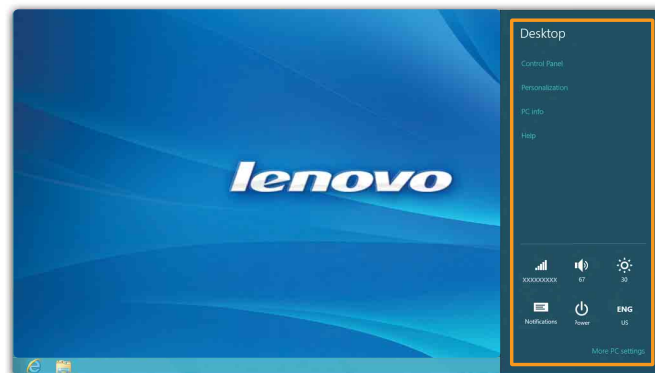

■ ■ Putting the computer to sleep or shutting it down ———

When you have finished working with your computer, you can put it to sleep or shut it down.

■ Putting your computer to sleep

If you will be away from your computer for only a short time, put the computer to sleep. When the computer is in sleep mode, you can quickly wake it to resume use, bypassing the startup process. To put the computer to sleep, do one of the following:

- Close the display panel.
- Press the power button.
- Open the charms bar, then select **Settings**  → **Power**  → **Sleep**.

⦿ **Attention:**

- Wait until the power indicator light starts blinking (indicating that the computer is in sleep mode) before you move your computer. Moving your computer while the hard disk is spinning can damage the hard disk, causing loss of data.

To wake the computer, do one of the following:

- Press any key on the keyboard.
- Press the power button.

Chapter 2. Starting to use Windows 8

■ Shutting down the computer

If you are not going to use your computer for a long time, shut it down.
To shut down your computer:

- 1 Open the charms bar, then select **Settings** .

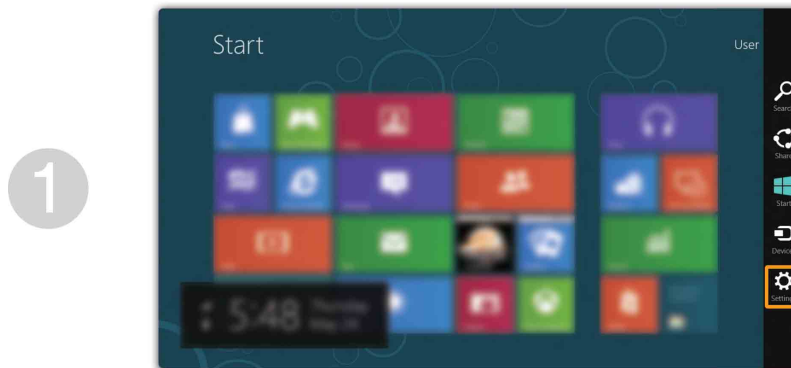

- 2 Select **Power**  → **Shut down**.

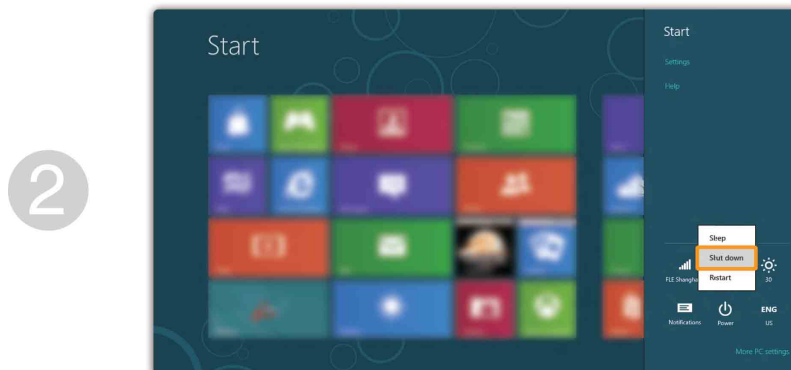

Touch screen operation

The display panel can accept inputs like a tablet, using its fully-featured, multi-touch screen; or like a traditional notebook computer, using keyboard and touch pad.

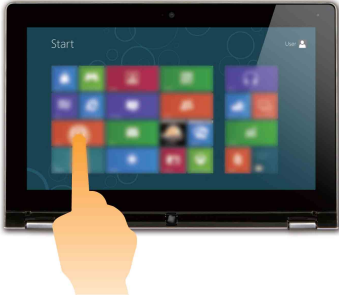
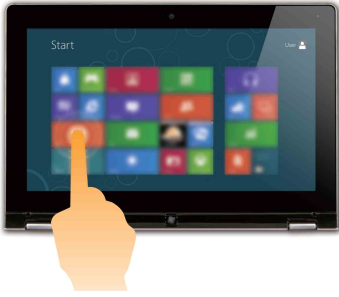

Multi-touch gestures

You can touch the screen with one or more fingertips to perform a variety of tasks.

Frequently used gestures	Tasks performed	Number of fingers used
<p>Tap Tap once on an item.</p> 	<p>Performs some action, such as starting an app, opening a link, or performing a command. Similar to left-clicking with a mouse.</p>	<p>one</p>
<p>Press and hold Press your finger down and leave it there for a moment.</p> 	<p>Allows you to see detailed information before selecting an action. Can also open a menu with more options. Similar to right-clicking with a mouse.</p>	<p>one</p>

Chapter 2. Starting to use Windows 8

(continued)

Frequently used gestures	Tasks performed	Number of fingers used
<p>Pinch Move two fingers together or apart while touching the screen.</p> 	<p>Zooms in and out on visual apps, such as pictures and maps. Can also jump to the beginning or end of a list.</p>	<p>two</p>
<p>Rotate Place two or more fingers on an item and then turn your hand.</p> 	<p>Rotating turns an object. (Note: Not all items can be rotated, depending upon the app.)</p>	<p>two or more</p>
<p>Slide Drag your finger across the screen.</p> 	<p>Pans or scrolls through lists and pages, but you can also use it to move an object or for drawing and writing, depending upon the app. Similar to pressing and holding to pan and to scroll with a mouse.</p>	<p>one</p>



(continued)

Frequently used gestures	Tasks performed	Number of fingers used
<p>Swipe Start from any edge of the screen, then swipe inwards toward the center.</p> 	<ul style="list-style-type: none"> • Swiping from the bottom or top edge displays app commands, including save, edit, and delete. This also can be used to dock or close the currently open app. Similar to right-clicking on an app with your mouse. • Swiping from the left displays a list of the apps currently running in the background. • Swiping from the right side of the screen displays the charms. Similar to placing your mouse in the lower-right corner of the screen. 	<p>one</p>

Chapter 2. Starting to use Windows 8

■ ■ Connecting to a wireless network

To connect to a wireless network, do the following:

- 1 Ensure the airplane mode is turned off. If the airplane mode is turned on, press the hotkey () to turn it off.
- 2 Open the charms bar and select **Settings**  → . A list of available wireless networks will be displayed.
- 3 Click a network name in the list, and then click **Connect**.

Note: Some networks require a network security key or passphrase for connection. To connect to one of those networks, ask the network administrator or the Internet service provider (ISP) for the security key or passphrase.

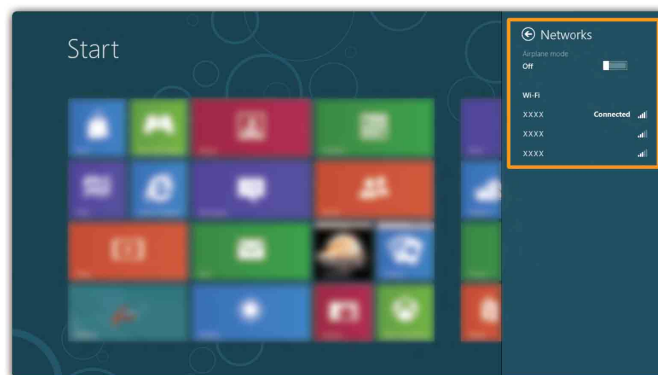

■ ■ Help and support

If you have questions about using the Windows operating system, refer to Windows Help and Support. To access Windows Help and Support, do one of the following:

- Open the charms bar and select **Settings**; select **Help** on the Settings menu.
- Press the Windows key  + **F1**.

Note: If hotkey mode is enabled, you need to press the Fn key and the F1 key in combination to access the F1 key function.

Chapter 3. Lenovo OneKey Recovery system

The Lenovo OneKey Recovery system is software designed to back up and restore your computer. You can use it to restore the system partition to its original status in case of a system failure. You can also create user backups for easy restoration as required.

Notes:

- If your computer is preinstalled with a GNU/Linux operating system, Onekey Recovery system is not available.
- To utilize the features of the OneKey Recovery system, your hard disk already includes a hidden partition by default to store the system image file and the OneKey Recovery system program files. This default partition is hidden for security reasons, which explains why the available disk space is less than the stated capacity.

■ Backing up the system partition

You can back up the system partition to an image file. To back up the system partition:

- ① Press the Novo button to start the Lenovo OneKey Recovery system.
- ② Click **System Backup**.
- ③ Select a back-up location and click **Next** to start the backup.

Notes:

- You can choose a back-up location on the local hard disk drive or an external storage device.
- The back-up process may take a while.
- The back-up process is only available when Windows can be started normally.

■ Restoring

You can choose to restore the system partition to its original status or to a previously created back-up point. To restore the system partition:

- ① Press the Novo button to start the Lenovo OneKey Recovery system.
- ② Click **System Recovery**. The computer will restart to the recovery environment.
- ③ Follow the on-screen instructions to restore the system partition to its original status or to a previously created back-up point.

Notes:

- The recovery process is irreversible. Make sure to back up any data you wish to save on the system partition before starting the recovery process.
- The recovery process may take a while. So be sure to connect the AC power adapter to your computer during the recovery process.
- The above instructions should be followed when Windows can be started normally.

Chapter 3. Lenovo OneKey Recovery system

If Windows cannot be started, follow the steps below to start the Lenovo OneKey Recovery system:

- ❶ Shut down the computer.
- ❷ Press the Novo button. From the **Novo button menu**, select **System recovery** and press Enter.

Chapter 4. Troubleshooting

■ ■ Frequently asked questions

This section lists frequently asked questions by category.

■ Finding information

What safety precautions should I follow when using my computer?

The *Lenovo Safety and General Information Guide* which came with your computer contains safety precautions for using your computer. Read and follow all the precautions when using your computer.

Where can I find the hardware specifications for my computer?

You can find hardware specification for your computer from the printed flyers which came with your computer.

Where can I find warranty information?

For the warranty applicable to your computer, including the warranty period and type of warranty service, see the Lenovo limited warranty flyer that came with your computer.

■ Drivers and preinstalled software

Where are the installation discs for Lenovo preinstalled software (desktop software)?

Your computer did not come with installation discs for Lenovo preinstalled software. If you need to reinstall preinstalled software, you can find the installation program on the D partition of your hard disk. If you cannot find the installation program there, download it from the Lenovo consumer support Web site.

Where can I find drivers for the various hardware devices of my computer?

If your computer is preinstalled with a Windows operating system, Lenovo provides drivers for the hardware devices that you need on the D partition of your hard disk. You can also download the latest device drivers from the Lenovo consumer support Web site.

■ **Lenovo OneKey Recovery system**

Where are the recovery discs?

Your computer did not come with recovery discs. Use the Lenovo OneKey Recovery system if you need to restore the system to its factory status.

What can I do if the back-up process fails?

If you can start the backup but it fails during the back-up process, try the following steps:

- ❶ Close all open programs, and then restart the back-up process.
- ❷ Check to see if the destination media is damaged. Select another path and then try again.

When do I need to restore the system to its factory status?

Use this feature when the operating system fails to start up. If there is critical data on the system partition, back it up before starting recovery.

■ **BIOS setup utility**

What is the BIOS setup utility?

The BIOS setup utility is ROM-based software. It communicates basic computer information and provides options for setting boot devices, security, hardware mode, and other preferences.

How can I start the BIOS setup utility?

To start the BIOS setup utility:

- ❶ Shut down the computer.
- ❷ Press the Novo button and then select **BIOS Setup**.

How can I change the boot mode?

There are two boot modes: **UEFI** and **Legacy Support**. To change the boot mode, start the BIOS setup utility and set boot mode to **UEFI** or **Legacy Support** on the boot menu.

Chapter 4. Troubleshooting

When do I need to change the boot mode?

The default boot mode for your computer is **UEFI** mode. If you need to install a legacy Windows operating system (that is, any operating system before Windows 8) on your computer, you must change the boot mode to **Legacy Support**. The legacy Windows operating system cannot be installed if you don't change the boot mode.

■ Getting help

How can I contact the customer support center?

See “Chapter 3. Getting help and service” of *Lenovo Safety and General Information Guide*.

● ● Troubleshooting

Display problems

When I turn on the computer, nothing appears on the screen.

- If the screen is blank, make sure that:
 - The AC power adapter is connected to the computer, and the power cord is plugged into a working electrical outlet.
 - The computer power is on. (Press the power button again for confirmation.)
 - If you are using the AC power adapter or the battery, and the battery status indicator is on, press **F12** () to make the screen brighter.

When I turn on the computer, only a white cursor appears on a blank screen.

- Restore backed-up files to your Windows environment or the entire contents of your hard disk to its original factory contents using the Lenovo OneKey Recovery system. If you still see only the cursor on the screen, have the computer serviced.

My screen goes blank while the computer is on.

- Your screen saver or power management may be enabled. Do one of the following to exit from the screen saver or to resume from sleep mode:
 - Touch the touch pad.
 - Press any key on the keyboard.
 - Press the power button.
 - Press **F9** () to confirm whether the backlight for the LCD screen has been turned off.
 - If the problem persists, follow the solution in the next problem "The screen is unreadable or distorted."

The screen is unreadable or distorted.

- Make sure that:
 - The display device driver is installed correctly.
 - The screen resolution and color quality are correctly set.
 - The monitor type is correct.

Chapter 4. Troubleshooting

Incorrect characters appear on the screen.

- Are the operating system or programs installed correctly? If they are installed and configured correctly, have the computer serviced.

BIOS password problems

I forgot my password.

- If you forget your user password, you must ask the system administrator to reset your user password.
- If you forget your HDD password, a Lenovo authorized servicer cannot reset your password or recover data from the hard disk. You must take your computer to a Lenovo authorized servicer or a marketing representative to have the hard disk drive replaced. Proof of purchase is required, and a fee will be charged for parts and service.
- If you forget your administrator password, a Lenovo authorized servicer cannot reset your password. You must take your computer to a Lenovo authorized servicer or a marketing representative to have the system board replaced. Proof of purchase is required, and a fee will be charged for parts and service.

Sleep problems

The critical low-battery error message appears, and the computer immediately turns off.

- The battery power is getting low. Connect the AC power adapter to the computer, or replace the battery with a fully charged one.

The computer enters sleep mode immediately after Power-on self-test (POST).

- Make sure that:
 - The battery is charged.
 - The operating temperature is within the acceptable range. See “Chapter 2. Use and care Information” of *Lenovo Safety and General Information Guide*.

Note: If the battery is charged and the temperature is within range, have the computer serviced.

The computer does not return from sleep mode, and the computer does not work.

- If your computer is in sleep mode, connect the AC adapter to the computer and then press any key or the power button.
- If the system still does not return from sleep mode, stops responding, or cannot be turned off, reset the computer. Unsaved data may be lost. To reset the computer, press and hold the power button for 4 seconds or more.

Sound problems

No sound can be heard from the speaker even when the volume is turned up.

- Make sure that:
 - The mute function is off.
 - The combo audio jack is not used.
 - The speaker is selected as the playback device.

Battery problems

Your computer shuts down before the battery status indicator shows empty.

-or-

Your computer operates after the battery status indicator shows empty.

The computer does not operate with a fully charged battery.

- Reset the battery gauge using Lenovo Energy Management. If the problem persists, replace with a new battery pack.
- The surge protector in the battery might be active. Turn off the computer for one minute to reset the protector; then turn on the computer again.

A hard disk drive problem

The hard disk drive does not work.

- In the **Boot** menu in the BIOS setup utility, make sure that the hard disk drive is included in the **EFI** list.

Chapter 4. Troubleshooting

Other problems

Your computer does not respond.

- To turn off your computer, press and hold the power button for 4 seconds or more. If the computer still does not respond, remove the battery pack and the AC power adapter.
- Your computer might lock when it enters sleep mode during a communication operation. Disable the sleep timer when you are working on the network.

I need to start the computer from a connected device, but the device does not appear on the boot device list.

- Check the boot mode setting in the BIOS setup utility. If **Boot Mode** is set to **UEFI**, make sure that the device or the medium in the device supports UEFI boot. If the device or the medium in the device does not support UEFI boot, set **Boot Mode** to **Legacy Support**. If the device still does not appear in the boot device list, replace with a new device or medium.

The connected external device does not work.

- Do not connect or disconnect any external device cables other than USB while the computer power is on; otherwise, you might damage your computer.
- When using a high power consumption external device such as an external USB optical disk drive, use an external device power adapter. Otherwise, the device may not be recognized, or system shut down may result.

Trademarks

The following terms are trademarks or registered trademarks of Lenovo in the United States, other countries, or both.

Lenovo
IdeaPad
OneKey

Microsoft and Windows are trademarks of Microsoft Corporation in the United States, other countries, or both.

Other company, products, or service names may be trademarks or service marks of others.



lenovo[®]

en-US
Rev. RB01