

Copyright and Trademark Information

Fujitsu Computer Systems Corporation has made every effort to ensure the accuracy and completeness of this document; however, as ongoing development efforts are continually improving the capabilities of our products, we cannot guarantee the accuracy of the contents of this document. We disclaim liability for errors, omissions, or future changes.

Fujitsu, the Fujitsu logo, and LifeBook are registered trademarks of Fujitsu Limited.

IBM, IBM PC AT, and IBM PS/2 are registered trademarks of International Business Machines Corporation in the United States, other countries, or both.

MS, MS-DOS, and Windows are either registered trademarks or trademarks of Microsoft Corporation in the United States and/or other countries.

ExpressCard™ Compliance IDs:

Model CP214460-01 - Compliance ID EC100009

Model CP242200-01 - Compliance ID EC100020

The ExpressCard word mark and logo are owned by the Personal Computer Memory Card International Association (PCMCIA) and any use of such marks by Fujitsu Computer Systems Corporation is under license.

PCMCIA is a trademark of the Personal Computer Memory Card International Association.

Intel and Pentium are trademarks or registered trademarks of Intel Corporation or its subsidiaries in the United States and other countries.

Bluetooth is a trademark of Bluetooth SIG, Inc., USA.

Adobe, Acrobat, and Acrobat Reader are either a registered trademarks or trademarks of Adobe Systems Incorporated in the United States and/or other countries.

Norton AntiVirus is a registered trademark of Symantec Corporation in the United States and other countries.

The DVD player found in some models of the LifeBook notebook incorporates copyright protection technology that is protected by method claims of certain U.S. patents and other intellectual property rights owned by Macrovision Corporation and other rights users. Use of this copyright protection technology must be authorized by Macrovision Corporation, and is intended for home and other limited viewing uses only unless authorized by Macrovision Corporation. Reverse engineering or disassembly is prohibited.

Dolby Headphone manufactured under license from Dolby Laboratories. Dolby, Pro Logic, and the double-D symbol are trademarks of Dolby Laboratories. Copyrights 1992-1999 Dolby Laboratories. All rights reserved.

All other trademarks mentioned herein are the property of their respective owners.

Warning



Handling the cord on this product will expose you to lead, a chemical known to the State of California to cause birth defects or other reproductive harm.

Wash hands after handling.

© Copyright 2004 Fujitsu Computer Systems Corporation. All rights reserved. No part of this publication may be copied, reproduced, or translated, without prior written consent of Fujitsu. No part of this publication may be stored or transmitted in any electronic form without the written consent of Fujitsu.

B6FH-5081-01EN-00



DECLARATION OF CONFORMITY

according to FCC Part 15

Responsible Party Name:	Fujitsu Computer Systems Corporation
Address:	1250 E. Arques Avenue, M/S 122 Sunnyvale, CA 94085
Telephone:	(408) 746-6000
Declares that product:	Base Model Configurations: LifeBook E8020 notebook LifeBook E8020D notebook Complies with Part 15 of the FCC Rules.

This device complies with Part 15 of the FCC rules. Operations are subject to the following two conditions: (1) This device must not be allowed to cause harmful interference, (2) This device must accept any interference received, including interference that may cause undesired operation.

IMPORTANT SAFETY INSTRUCTIONS

This unit requires an AC adapter to operate. Use only UL Listed Class 2 Adapters with an output rating of 19 VDC, with a current of 4.22 A.

AC adapter output polarity:



When using your notebook equipment, basic safety precautions should always be followed to reduce the risk of fire, electric shock and injury to persons, including the following:

- Do not use this product near water for example, near a bathtub, washbowl, kitchen sink or laundry tub, in a wet basement or near a swimming pool.
- Avoid using the modem during an electrical storm. There may be a remote risk of electric shock from lightning.
- Do not use the modem to report a gas leak in the vicinity of the leak.
- Use only the power cord and batteries indicated in this manual. Do not dispose of batteries in a fire. They may explode. Check with local codes for possible special disposal instructions.
- To reduce the risk of fire, use only No. 26 AWG or larger UL Listed or CSA Certified Telecommunication Line Cord.

SAVE THESE INSTRUCTIONS

For Authorized Repair Technicians Only



Danger of explosion if Lithium (clock) battery is incorrectly replaced. Replace only with the same or equivalent type recommended by the manufacturer. Dispose of used batteries according to the manufacturer's instruction.



For continued protection against risk of fire, replace only with the same type and rating fuse.

System Disposal



LAMP(S) INSIDE THIS PRODUCT CONTAIN MERCURY AND MUST BE RECYCLED OR DISPOSED OF ACCORDING TO LOCAL, STATE, OR FEDERAL LAWS.

Fujitsu LifeBook® E8000 Notebook

Table of Contents

1

PREFACE

Preface

About This Guide	1
Fujitsu Contact Information	1
Limited Warranty	1

2

GETTING TO KNOW YOUR LIFEBOOK NOTEBOOK

Overview

Unpacking	5
---------------------	---

Locating the Controls & Connectors

Top Components	6
Front Panel Components	7
Left-Side Panel Components	8
Right-Side Panel Components	9
Back Panel Components	10
Bottom Components	11

Status Indicator Panel

Power Indicator	12
AC Adapter Indicator	12
Battery Level Indicators	12
Battery Charging Indicators	13
WLAN Access Indicator	13
Optical Drive Access Indicator	13
Hard Drive/Removable Drive Access Indicator	13
PC Card Access Indicator	13
NumLk Indicator	13
CapsLock Indicator	13
ScrLk Indicator	13
Security Indicator	13

Keyboard

Using the Keyboard	14
Numeric Keypad	14
Windows Keys	14
Cursor Keys	14
Function Keys	15

Touchpad Pointing Device

Clicking	16
Double-Clicking	16
Dragging	17
Touchpad Control Adjustment	17
Scrolling	17
Optional Quick Point Feature	17

Volume Control

Controlling the Volume	18
----------------------------------	----

Flexible Bay Devices

Removing and Installing Modular Devices	19
---------------------------------------------------	----

LifeBook Security/Application Panel

Setting up Your LifeBook Security Panel	20
Passwords	20
Operating Your Security/ Application Panel	21
Precautions	21
Uninstalling the Security Panel Application	21
Launching Applications with Application Panel	22

3

GETTING STARTED

Power Sources

Connecting the Power Adapters	27
-----------------------------------------	----

Display Panel

Opening the Display Panel	28
Adjusting Display Panel Brightness	28
Closing the Display Panel	28

Starting Your LifeBook Notebook

Power On	29
Boot Sequence	29
BIOS Setup Utility	29
Booting the System	30
Windows Product Activation	30
Registering Your LifeBook Notebook	31
Installing Click Me!	31

Power Management

Power/Suspend/Resume Button	32
Suspend Mode	32
Hibernation (Save-to-Disk) Feature	32
Display Timeout	33
Hard Disk Timeout	33
Windows Power Management	33
Restarting the System	33
Power Off	33

4

USER-INSTALLABLE FEATURES

Lithium ion Battery

Recharging the Batteries	37
Replacing the Battery	38

Optical Drive

Media Player Software	39
Loading Media on Your Drive	39
Removing Media	40
Using the Media Player Software	40
Using Dolby™ Headphone	41
Using Media Player on Battery Power	41

External USB Floppy Disk Drive

Loading a Disk	42
Ejecting a Disk	42
Preparing a Disk for Use	42

Multimedia Card/SD Media

Installing MMC/SD Cards	43
Removing An MMC/SD Card	43

PC Cards/ExpressCards™

Installing/Removing PC Cards	44
Installing/Removing ExpressCards	44
Smart Card Reader	45

Memory Upgrade Module

Installing Memory Upgrade Modules	46
Removing a Memory Upgrade Module	46
Checking the Memory Capacity	46

Device Ports

Modem (RJ-11) Telephone Jack	48
Internal LAN (RJ-45) Jack	48
Parallel Port	48
Serial Port	49
PS/2 Port	49
Docking Port	49
Universal Serial Bus Ports	49
Infrared Port	49
IEEE 1394 Port	50
Headphone Jack	50
Microphone Jack	50
External Monitor Port	50

5

TROUBLESHOOTING

Troubleshooting

Identifying the Problem	53
Specific Problems	53
Troubleshooting Table	54
Power On Self Test Messages	62
Emergency media Player Drive Tray Release	63
Modem Result Codes	63
Restoring Your Pre-installed Software	64
Restoring the Factory Image	64
Automatically Downloading Driver Updates	65

6

CARE AND MAINTENANCE

Care and Maintenance

Batteries	70
Floppy Disks and Drives	70
Media Care	70
PC Cards/ExpressCards	71

7

SPECIFICATIONS

Specifications

Configuration Label	75
Microprocessor	75
Chipset	75
Memory	75
Video	75
Audio	75
Mass Storage Device Options	76
Features	76
Device Ports	76
Keyboard.	77
Power	77
Dimensions and Weight	77
Environmental Requirements	77
Popular Accessories	77
Pre-Installed Software	78
Learning About Your Software	78

8

GLOSSARY

Glossary	81
Regulatory Information	87

APPENDIX: INTEGRATED WIRELESS LAN USER'S GUIDE

Before Using the Wireless LAN

Wireless LAN Modes Using this Device	92
Wireless Network Considerations	93
Deactivating the WLAN Device	93
Activating the WLAN Device	94

Configuration of the WLAN Device

Flow of Operations	95
Configuration Using Wireless Zero Tool	95
Configuration Using Intel PROSet Software	96
Configuration Using Atheros Client Utility	97
Connection to the network	99

Troubleshooting the WLAN

Troubleshooting	102
---------------------------	-----

Wireless LAN Glossary

Glossary	103
--------------------	-----

IP address information

Additional information	105
----------------------------------	-----

Specifications

Specification	106
-------------------------	-----

Using the Bluetooth Device

What is Bluetooth	107
Where to Find Information About Bluetooth	107

Index

Index	109
-----------------	-----



Preface

ABOUT THIS GUIDE

The LifeBook E8000 notebook from Fujitsu is a powerful computer, powered by an Intel Pentium M microprocessor. Depending upon the configuration, the notebook has either a built-in 15" TFT XGA or SXGA+ color display. This system brings the computing power of desktop personal computers (PCs) to a portable environment.

Your computer comes with Microsoft Windows® XP Home, or XP Professional pre-installed.

This manual explains how to operate your LifeBook notebook's hardware and built-in system software.

Conventions Used in the Guide

Keyboard keys appear in brackets.

Example: [Fn], [F1], [ESC], [ENTER] and [CTRL].

Pages with additional information about a specific topic are cross-referenced within the text.

For example: (See page xx.)

On screen buttons or menu items appear in bold

Example: Click **OK** to restart your LifeBook notebook.

DOS commands you enter appear in Courier type.

Example: Shutdown the computer?



The information icon highlights information that will enhance your understanding of the subject material.



The caution icon highlights information that is important to the safe operation of your computer, or to the integrity of your files. Please read all caution information carefully.



The warning icon highlights information that can be hazardous to either you, your LifeBook notebook, or your files. Please read all warning information carefully.

FUJITSU CONTACT INFORMATION

Service and Support

You can contact Fujitsu Service and Support in the following ways:

- Toll free: 1-800-8Fujitsu (1-800-838-5487)
- E-mail: 8fujitsu@us.fujitsu.com
- Web site:
http://www.computers.us.fujitsu.com/support

Before you place the call, you should have the following information ready so that the customer support representative can provide you with the fastest possible solution:

- Product name
- Product configuration number
- Product serial number
- Purchase date
- Conditions under which the problem occurred
- Any error messages that have occurred
- Type of device connected, if any

Fujitsu Online

You can go directly to the online Fujitsu Product catalog for your LifeBook notebook by clicking on Start -> Fujitsu Weblinks -> LifeBook Accessories Web Site.

You can also reach Fujitsu Service and Support online by clicking on Start -> Fujitsu Weblinks -> Fujitsu Service and Support.



You must have an active internet connection to use the online URL links.

LIMITED WARRANTY

Your LifeBook notebook is backed by a Fujitsu International Limited Warranty. Check the service kit that came with your notebook for the Limited Warranty period and terms and conditions.



Getting to Know Your LifeBook Notebook

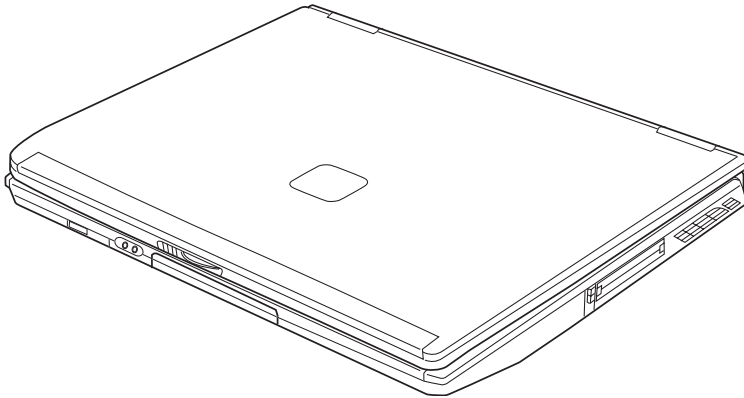

Figure 2-1. Fujitsu LifeBook E8000 notebook

Overview

This section describes the components of your Fujitsu LifeBook E8000 notebook. We strongly recommend that you read it before using your notebook – even if you are already familiar with notebook computers.

UNPACKING

When you receive your LifeBook notebook, unpack it carefully, and compare the parts you have received with the items listed below.

For a pre-configured model you should have:

- LifeBook E8000 notebook (*Figure 2-1*)
- AC adapter with AC power cord (*Figure 2-2*)
- Lithium ion Battery, pre-installed
- Weight Saver
- Phone/Modem (RJ-11) telephone cable
- Driver and Application Restore (DAR) Disc
- Getting Started Guide
- User's Guide (this document)
- International Limited Warranty Brochure
- Microsoft®-associated product materials

Depending on your system configuration, one of the following devices will be pre-installed in the Flexible Bay:

- Weight Saver
- Modular Multi-Format DVD Writer
- Modular DVD/CD-RW combo drive
- Modular DVD-ROM drive

Depending on your system configuration, the following optional items may be included with your system:

- Modular 2nd bay battery
- External USB floppy disk drive

Depending on your configuration, you may receive the following application CDs:

- RecordNow! CD
- InterVideo WinDVR/RecordNow! CD
- Trusted Platform Module (TPM) Driver and Application CD
- Bluetooth Application CD

Once you have checked and confirmed that your LifeBook system is complete, read through the following pages to learn about all of your notebook's components.

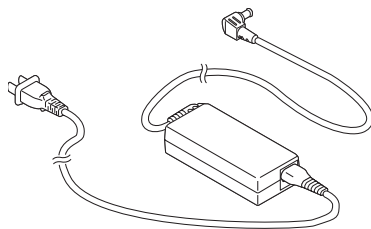

Figure 2-2 AC Adapter

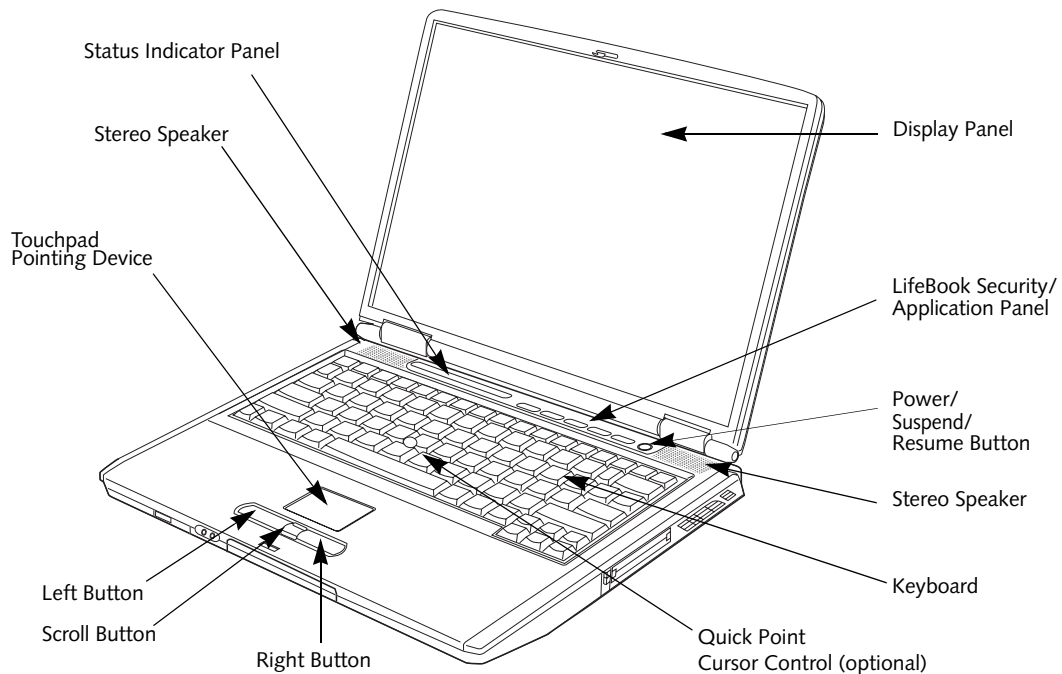

Figure 2-3. LifeBook notebook with display open

Locating the Controls and Connectors

TOP COMPONENTS

The following is a brief description of your LifeBook notebook's top components.

Display Panel

The display panel is a color LCD panel with back lighting for the display of text and graphics.

LifeBook Security/Application Panel

The LifeBook Security/Application Panel provides hardware security and one-touch application launch capability. (See *LifeBook Security/Application Panel on page 20 for more information*)

Power/Suspend/Resume Button

The Power/Suspend/Resume button allows you to suspend notebook activity without powering off, resume your LifeBook notebook from suspend mode, and power on your notebook when it has been shut down from Windows. (See *Power/Suspend/Resume Button on page 32 for more information*)

Stereo Speakers

The built-in dual speakers allow for stereo sound.

Keyboard

A full-size keyboard with dedicated Windows keys. (See *Keyboard on page 14 for more information*)

Touchpad Pointing Device

The Touchpad pointing device is a mouse-like cursor control with three buttons: two mouse-like buttons, and a scroll button. (See *Touchpad Pointing Device on page 16 for more information*)

Quick Point Cursor Control (optional)

The optional Quick Point control offers an additional method for moving the cursor. (See *Optional Quick Point Feature on page 17 for more information*)

Status Indicator Panel

The Status Indicator Panel displays symbols that correspond with a specific component of your LifeBook notebook. (See *Status Indicator Panel on page 12 for more information*)

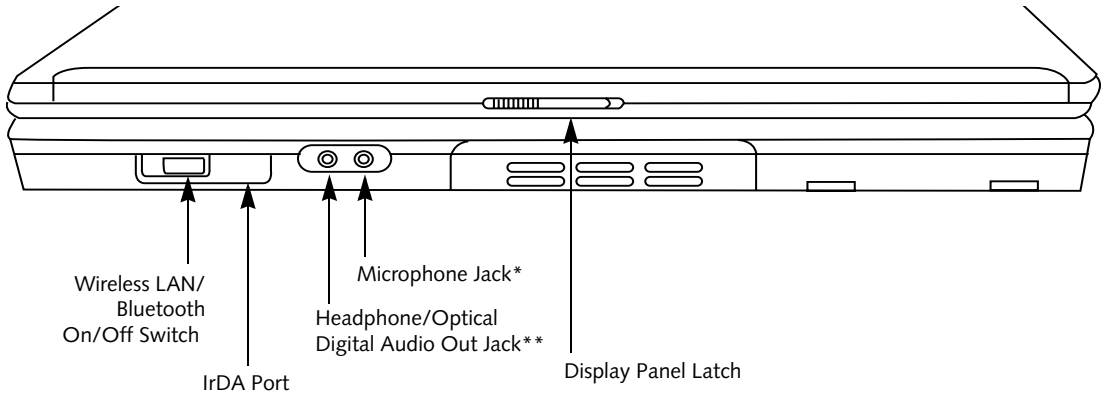

Figure 2-4. LifeBook notebook - front panel

FRONT PANEL COMPONENTS

Wireless LAN/Bluetooth On/Off Switch

The wireless LAN/Bluetooth on/off switch is used to turn on and off the optional WLAN and Bluetooth devices. Switching the device off when not in use will help to extend battery life. (Note that either or both devices can be turned on and off using this switch). (See *Activating the WLAN Device on page 94 for more information*)

Microphone Jack*

The microphone jack allows you to connect an external mono microphone. (See *Microphone Jack** on page 50 for more information*)

Headphone/SPDIF Jack**

The headphone/optical digital audio jack allows you to connect headphones or to download digital audio onto a MiniDisc recorder's SPDIF (Sony Philips Digital Interface) format. (See *Optical Digital Audio Connector on page 46 for more information*)

Display Panel Latch

The display panel latch locks and releases the display panel.

IrDA port

Provides an infrared interface for communication with devices compliant with IrDA Standard Revision 1.1.

* Depending upon your system configuration, the microphone jack may serve single or dual purposes. On configurations, the jack serves as a mono microphone jack. On other configurations, the jack serves as a stereo microphone/line-in jack.

** Depending upon your system configuration, the headphone jack may serve different purposes. On some configurations, the jack serves as a stereo headphone/Optical Digital Audio Out jack. On other configurations, the jack serves as a stereo headphone/Line-Out/Optical Digital Audio Out jack.

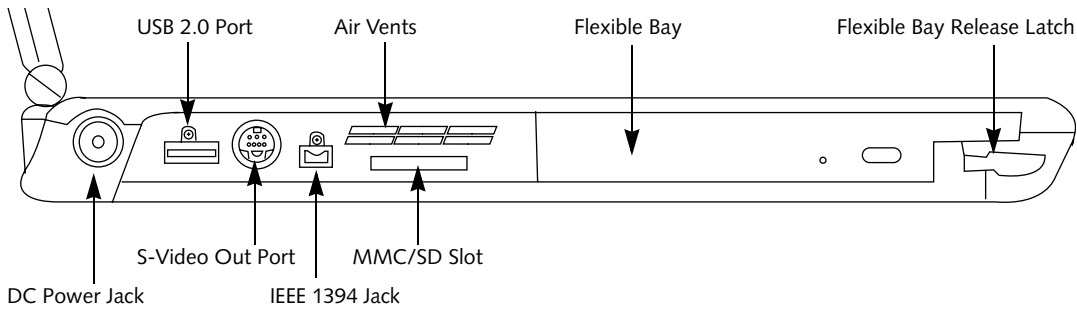

Figure 2-5. LifeBook notebook left-side panel

LEFT-SIDE PANEL COMPONENTS

The following is a brief description of your LifeBook notebook's left-side components.

USB 2.0 Port

The USB 2.0 port allows you to connect Universal Serial Bus devices. USB 2.0 transfers data at up to 480 Mbps and is backward-compatible with USB 1.1 devices, which transfer data at up to 12 Mbps. (See *Universal Serial Bus Ports on page 49 for more information*)

Flexible Bay

The Flexible Bay can accommodate one of the following devices. (See *Flexible Bay Devices on page 19 for more information*)

- Modular CD-ROM drive
- Modular DVD/CD-RW combo drive
- Modular Multi-Format DVD Writer
- Modular Lithium ion battery
- Weight Saver

Flexible Bay Release Latch

The Flexible Bay release latch releases the Flexible Bay device.

IEEE 1394 (4-pin) Jack

The 4-pin 1394 jack is used to connect between your notebook and an IEEE 1394 peripheral such as a digital video camera. (See *IEEE 1394 Port on page 50 for more information*)

DC Power Jack

The DC power jack allows you to plug in the AC adapter to power your LifeBook notebook and charge the internal Lithium ion battery.

MMC/SD Slot

The SD/MMC slot allows you to install a Secure Digital (SD) card or a Multimedia Card (MMC) for data storage. This architecture allows you to transfer data from a variety of different digital devices. (See *Installing MMC/SD Cards on page 43 for more information*)

S-Video Out Port

The S-Video output is used to transmit a higher resolution video signal to a compatible TV or VCR. (See *S-Video Out Port on page 47 for more information*)

Air Vents

The air vents allow air to circulate through the system to cool down the components.



Be sure not to block the air vents while the system is operating, or damage to internal components may occur.

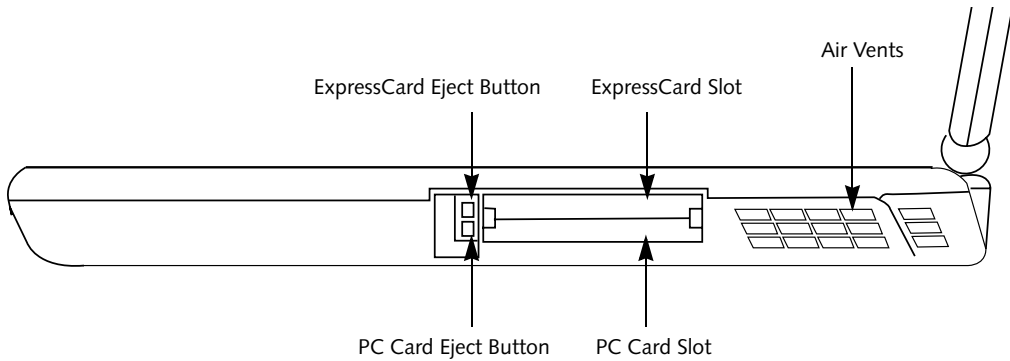

Figure 2-6. LifeBook notebook right-side panel

RIGHT-SIDE PANEL COMPONENTS

The following is a brief description of your LifeBook notebook's right-side components.

ExpressCard Slot

The ExpressCard slot allows you to install an ExpressCard. (See *PC Cards/ExpressCards™* on page 44 for more information)

ExpressCard Eject Button

The ExpressCard eject button is used for removing an ExpressCard from the slot.

PC Card Slot

The PC Card Slots allow you to install a Type I or Type II PC Card. (See *PC Cards/ExpressCards™* on page 44 for more information)

PC Card Eject Button

The PC Card eject button is used for removing a PC Card from the slot.

Air Vents

The air vents allow air to circulate through the system to cool down the components.



Be sure not to block the air vents while the system is operating, or damage to internal components may occur.

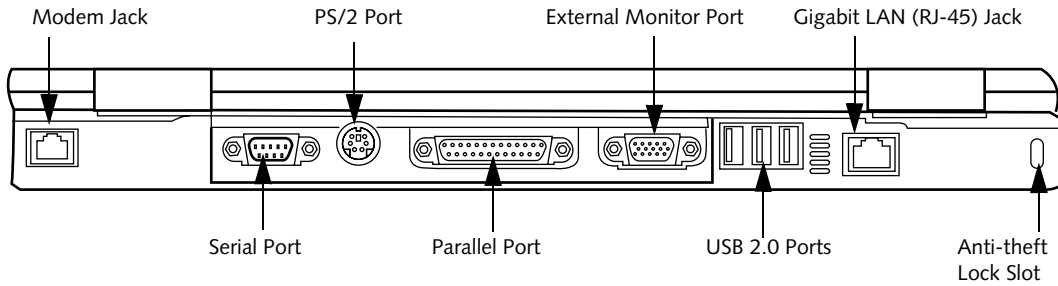

Figure 2-7. LifeBook notebook back panel

BACK PANEL COMPONENTS

Following is a brief description of your LifeBook notebook's back panel components.

USB 2.0 Ports

The USB 2.0 ports allow you to connect Universal Serial Bus devices. USB 2.0 transfers data at up to 480Mbps and is backward-compatible with USB 1.1 devices, which transfer data at up to 12Mbps. (See *Universal Serial Bus Ports* on page 49 for more information)

Gigabit LAN (RJ-45) Jack

The internal LAN (RJ-45) jack is used for an internal Gigabit (10Base-T/100Base-Tx/1000Base-T) Ethernet LAN connection. (See *Internal LAN (RJ-45) Jack* on page 48 for more information)

External Monitor Port

The external monitor port allows you to connect an external monitor. (See *External Monitor Port* on page 50 for more information)

Modem (RJ-11) Telephone Jack

The Modem (RJ-11) telephone jack is for attaching a telephone line to the internal multinational 56K modem. (See *Modem (RJ-11) Telephone Jack* on page 48 for more information)



The internal modem is not intended for use with Digital PBX systems. Do not connect the internal modem to a Digital PBX as it may cause serious damage to the internal modem or your entire notebook. Consult your PBX manufacturer's documentation for details. Some hotels have Digital PBX systems. Be sure to find out BEFORE you connect your modem.



The internal multinational modem is designed to the ITU-T V.90/v.92 standard. Its maximum speed of 53000bps is the highest allowed by FCC, and its actual connection rate depends on the line conditions. The maximum speed is 33600 bps at upload, in accordance with FCC regulations.

For additional information about the modem, refer to the Fujitsu web site at: <http://www.computers.us.fujitsu.com>

USB 2.0 Port

The USB 2.0 port allows you to connect Universal Serial Bus devices. USB 2.0 transfers data at up to 480Mbps and is backward-compatible with USB 1.1 devices, which transfer data at up to 12Mbps. (See *Universal Serial Bus Ports* on page 49 for more information)

Anti-theft Lock Slot

The anti-theft lock slot allows you to attach an optional physical lock down device.

Serial Port

The serial port allows you to connect serial RS-232 devices, such as serial printers or serial scanners. (See *Serial Port* on page 48 for more information)

Parallel Port

The parallel port allows you to connect parallel devices, such as a printer. (This is also sometimes referred to as an LPT port.) (See *Parallel Port* on page 48 for more information)

PS/2 Port

The PS/2 port allows you to connect an external PS/2 keyboard or mouse. (See *PS/2 Port* on page 55 for more information)



The PS/2 port is a legacy port, and will only work under Windows XP if additional third-party drivers are installed.

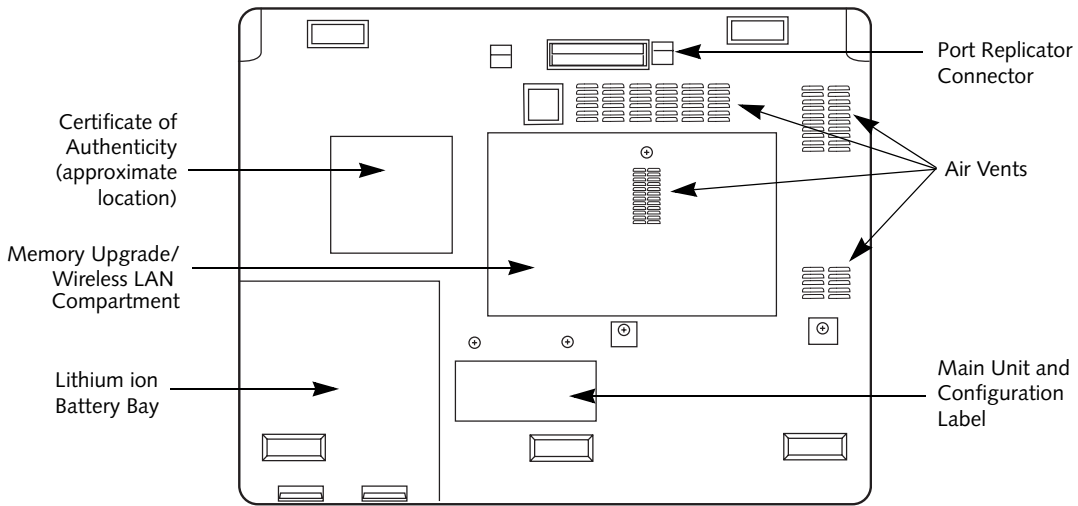

Figure 2-8. LifeBook notebook bottom panel

BOTTOM COMPONENTS

The following is a brief description of your LifeBook notebook's bottom panel components.

Port Replicator Connector

This connector allows you to connect the optional Port Replicator to your notebook.

Memory Upgrade/Wireless Device Compartment

Your notebook comes with high speed Double Data Rate Synchronous Dynamic RAM (DDR SDRAM). The memory upgrade compartment allows you to expand the system memory capacity of your notebook, thus improving overall performance. (See *Memory Upgrade Module on page 46 for more information*).

This compartment also houses the optional wireless LAN device. Under normal circumstances, it should not be necessary to open this compartment.

Lithium ion Battery Bay

The battery bay contains the internal Lithium ion battery. It can be opened for the removal of the battery when stored over a long period of time or for swapping

a discharged battery with a charged Lithium ion battery. (See *Lithium ion Battery on page 37 for more information*)

Main Unit and Configuration Label

The configuration label shows the model number and other information about your notebook. In addition, the configuration portion of the label has the serial number and manufacturer information that you will need to give your support representative. It identifies the exact version of various components of your notebook.

Air Vents

The air vents allow air to circulate through the system to cool down the components.



Be sure not to block the air vents while the system is operating, or damage to internal components may occur.

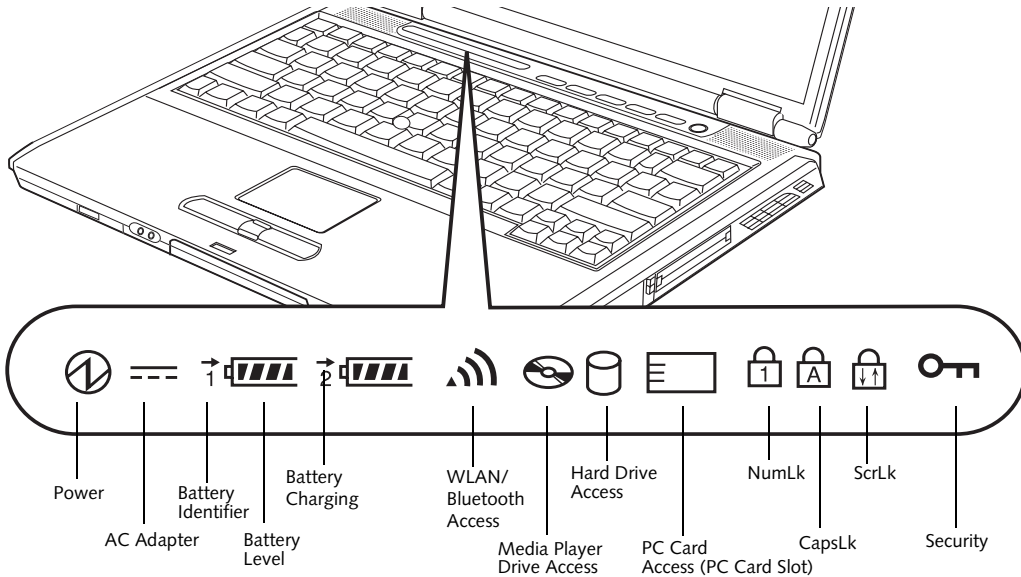

Figure 2-9. Status Indicator Panel

Status Indicator Panel

The Status Indicator displays symbols that correspond with a specific component of your Fujitsu LifeBook notebook. These symbols tell you how each of those components are operating. (Figure 2-9)

POWER INDICATOR

The Power indicator symbol states whether your system is operational. It has several different states, each of which tells you the mode your notebook is in.

- **Steady On:** This means that there is power to your LifeBook notebook and that it is ready for use.
- **Flashing:** This means that your notebook is in Suspend mode.
- **Steady Off:** This means that your system is either in Save-to-Disk mode, or that your notebook has been turned off.

If you are charging your battery, the Power indicator will remain on even if your notebook is shut off. The Power indicator will also remain on if you have either adapter connected and are shut down from Windows.

AC ADAPTER INDICATOR

The AC Adapter indicator shows whether your notebook is operating from the AC adapter, Auto/Airline adapter or battery(s). This icon has two different states that can tell you what power source your notebook is using.

- **On:** This means that either of the adapters are currently in use.
- **Off:** Power is only coming from the batteries, and you do not have an adapter connected.

BATTERY LEVEL INDICATORS

The two Battery Level indicators state whether or not the primary Lithium ion battery and/or the optional second Lithium ion battery are installed (Battery 1 refers to the primary Lithium ion battery, while Battery 2 refers to the Flexible Bay optional second battery). In addition, this symbol states how much charge is available within each installed battery. The symbol will only be displayed for a battery that is currently installed in your LifeBook notebook. (Figure 2-10)

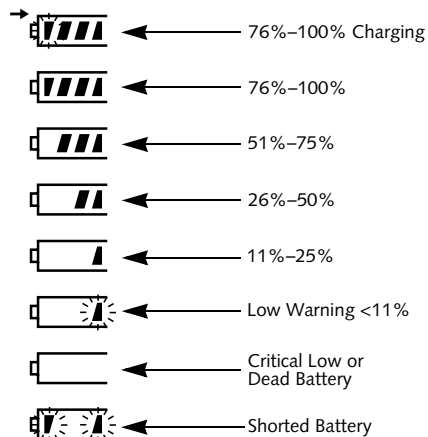

Figure 2-10 Battery Level Indicator



A shorted battery is damaged and must be replaced. (Figure 2-10)

→ BATTERY CHARGING INDICATORS

Located to the left of each of the Battery Level indicators is a small arrow symbol. This symbol states whether that specific battery is charging. This indicator will flash if the battery is too hot or cold to charge.



Batteries subjected to shocks, vibration or extreme temperatures can be permanently damaged.



WLAN ACCESS INDICATOR

The WLAN access indicator appears when the Wireless LAN or Bluetooth is enabled.



DVD/CD-RW/CD-ROM DRIVE ACCESS INDICATOR

The DVD/CD-RW/CD-ROM Access indicator tells you that the DVD/CD-RW/CD-ROM drive is being accessed. If the Auto Insert Notification function is active, the indicator will flash periodically when your system is checking the DVD/CD-RW/CD-ROM drive. If the Auto Insert Notification function is not active, the indicator will only flash when you access the DVD/CD-RW/CD-ROM drive. The default setting is the Auto Insert Notification function active.



The DVD/CD-RW/CD-ROM Auto Insert Notification function will periodically check for a DVD/CD-RW/CD-ROM installed in the drive, causing the DVD/CD-RW/CD-ROM Access indicator to flash. The DVD/CD-RW/CD-ROM Auto Insert Notification function allows your system to start a DVD/CD-RW/CD-ROM automatically as soon as it is inserted in the drive and the tray is closed. It will begin playing an audio DVD/CD or will start an application if the DVD/CD has an auto-run file



HARD DRIVE OR REMOVABLE MEDIA DRIVE ACCESS INDICATOR

The Hard Drive Access indicator states whether your internal hard drive is being accessed.



The Hard Drive Access indicator does not show which hard drive is being accessed.



PC CARD ACCESS INDICATOR

The PC Card Access indicator shows whether or not your notebook is accessing a PC Card. The indicator will flash if your software tries to access a PC Card even if there is no card installed. (See *PC Cards/ExpressCards™* on page 44 for more information)



NUMLK INDICATOR

The NumLk indicator states that the integral keyboard is set in ten-key numeric keypad mode.



CAPSLCK INDICATOR

The CapsLock indicator states that your keyboard is set to type in all capital letters.



SCRCLK INDICATOR

The ScrLk indicator states that your scroll lock is active.



SECURITY INDICATOR

The Security Indicator flashes (if a password was set) when the system resumes from Off or Standby modes. You must enter the password that was set in the Security Panel before your system will resume operation.

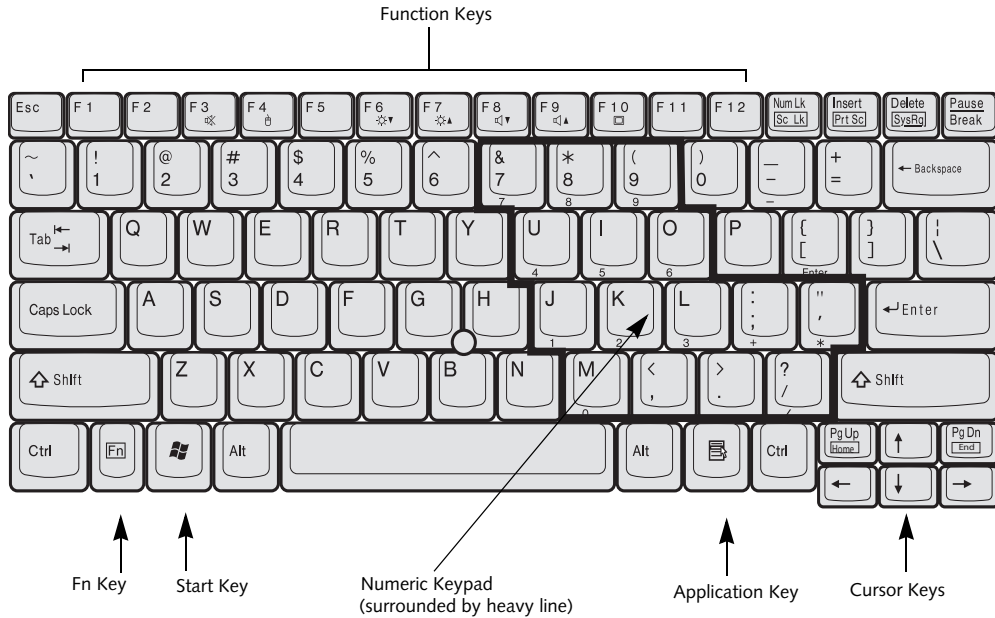

Figure 2-11 Keyboard

Keyboard

USING THE KEYBOARD

Your Fujitsu LifeBook notebook has an integral 84-key keyboard. The keys perform all the standard functions of a 101-key keyboard, including the Windows keys and other special function keys. This section describes the following keys. (Figure 2-11)

- **Numeric keypad:** Your notebook allows certain keys to serve dual purposes, both as standard characters and as numeric and mathematical keys. The ability to toggle between the standard character and numerical keys is controlled through the [NumLk] key.
- **Cursor keys:** Your keyboard contains four arrow keys for moving the cursor or insertion point to the right, left, up, or down within windows, applications and documents.
- **Function keys:** The keys labeled [F1] through [F12], are used in conjunction with the [Fn] key to produce special actions that vary depending on what program is running.
- **Windows keys:** These keys work with your Windows operating system and function the same as the onscreen Start menu button, or the right button on your pointing device.

NUMERIC KEYPAD

Certain keys on the keyboard perform dual functions as both standard character keys and numeric keypad keys. NumLk can be activated by pressing the [NumLk] keys. Turning off the NumLk feature is done the same way. Once this feature is activated you can enter numerals 0 through 9, perform addition (+), subtraction (-), multiplication (*), or division (/), and enter decimal points (.) using the keys designated as ten-key function keys. The keys in the numeric keypad are marked on the front edge of the key to indicate their secondary functions. (Figure 2-11)

WINDOWS KEYS

Your LifeBook notebook has two Windows keys, consisting of a Start key and an Application key. The Start key displays the Start menu. This button functions the same as your onscreen Start menu button. The Application key functions the same as your right mouse button and displays shortcut menus for the selected item. (Please refer to your Windows documentation for additional information regarding the Windows keys.) (Figure 2-11)

CURSOR KEYS

The cursor keys are the four arrow keys on the keyboard which allow you to move the cursor up, down, left and right in applications. In programs such as Windows Explorer, it moves the “focus” (selects the next item up, down, left, or right). (Figure 2-11)

FUNCTION KEYS

Your LifeBook notebook has 12 function keys, F1 through F12. The functions assigned to these keys differ for each application. You should refer to your software documentation to find out how these keys are used.

(Figure 2-11)

The [Fn] key provides extended functions for the notebook and is always used in conjunction with another key.

- [Fn+F3]: Pressing [F3] while holding [Fn] will toggle the Audio Mute on and off.
- [Fn+F4]: Pressing [F4] while holding [Fn] will toggle the Quick Point feature on and off. Note that the [Fn+F4] combination only works if Manual Setting is selected in the BIOS. (See “BIOS Setup Utility” on page 29)
- [Fn+F5]: Pressing [F5] while holding [Fn] allows you to toggle between video compensation and no compensation. (Video compensation controls spacing on the display. When it is enabled, displays with less than standard pixel resolution will still cover the entire screen.)
- [Fn+F6]: Pressing [F6] repeatedly while holding [Fn] will lower the brightness of your display.*
- [Fn+F7]: Pressing [F7] repeatedly while holding [Fn] will increase the brightness of the display.*
- [Fn+F8]: Pressing [F8] repeatedly while holding [Fn] will decrease the volume of your LifeBook notebook.**
- [Fn+F9]: Pressing [F9] repeatedly while holding [Fn] will increase the volume of your LifeBook notebook.**
- [Fn+F10]: Pressing [F10] while holding [Fn] allows you to change your selection of where to send your display video. Each time you press the combination of keys you will step to the next choice. The choices, in order, are: built-in display panel only, both built-in display panel and external monitor or external monitor only.

* There are eight brightness levels.

** There are 26 audio levels.

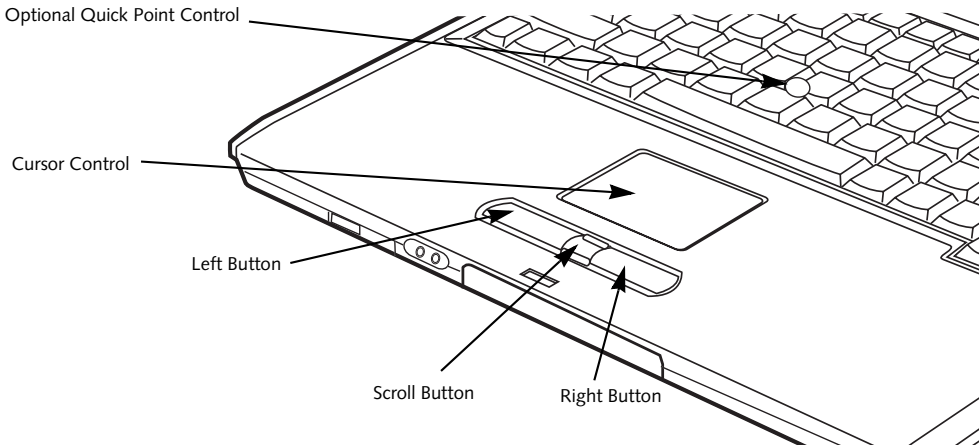

Figure 2-12. Touchpad pointing device

Touchpad Pointing Device



Certain E8000 LifeBook notebooks are equipped with an optional "Quick Point" button for moving the cursor. For more information about Quick Point, see "Optional Quick Point Feature" on page 17.

The Touchpad pointing device comes built into your Fujitsu LifeBook notebook. It is used to control the movement of the pointer to select items on your display panel. The Touchpad is composed of a cursor control, a left and right button, and a scrolling button. The cursor control works the same way a mouse does, and moves the cursor around the display. It only requires light pressure with the tip of your finger. The left and right buttons function the same as mouse buttons. The actual functionality of the buttons may vary depending on the application that is being used. The scrolling button allows you to navigate quickly through pages, without having to use the scroll bars. (Figure 2-12)



An external mouse can be connected to either the USB or PS/2 ports on your LifeBook notebook or the optional port replicator, and used simultaneously with the Touchpad. However, if you boot the system with an external mouse connected the Touchpad will be disabled or enabled depending on the specifications in your BIOS settings. (See *BIOS Setup Utility* on page 29 for more information)

CLICKING

Clicking means pushing and releasing a button. To left-click, move the cursor to the item you wish to select, press the left button once, and then immediately release it. To right-click, move the mouse cursor to the item you wish to select, press the right button once, and then immediately release it. You also have the option to perform the clicking operation by tapping lightly on the Touchpad once. (Figure 2-13)

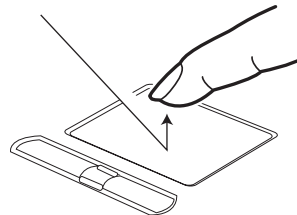

Figure 2-13 Clicking

DOUBLE-CLICKING

Double-clicking means pushing and releasing the left button twice in rapid succession. This procedure does not function with the right button. To double-click, move the cursor to the item you wish to select, press the left button twice, and then immediately release it. You also have the option to perform the double-click operation by tapping lightly on the Touchpad twice. (Figure 2-14)

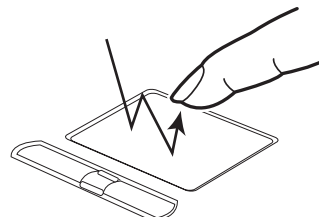

Figure 2-14 Double-clicking



- If the interval between clicks is too long, the double-click will not be executed.
- Parameters for the Touchpad can be adjusted from the Mouse Properties dialog box located in the Windows Control Panel.

DRAGGING

Dragging means pressing and holding the left button, while moving the cursor. To drag, move the cursor to the item you wish to move. Press and hold the left button while moving the item to its new location and then release it. Dragging can also be done using the Touchpad. First, tap the Touchpad twice over the item you wish to move making sure to leave your finger on the pad after the final tap. Next, move the object to its new location by moving your finger across the Touchpad, and then release your finger. (Figure 2-15)

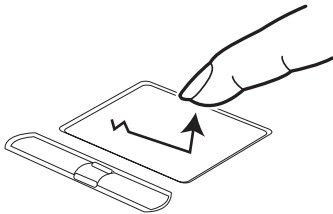

Figure 2-15 Dragging

TOUCHPAD CONTROL ADJUSTMENT

The Windows Control Panel allows you to customize your Touchpad with selections made from within the Mouse Properties dialog box.

SCROLLING

Using the Scrolling button allows you to navigate through a document quickly without using the window's scroll bars. This is particularly useful when you are navigating through on-line pages. To use the Scrolling button, press the crescent shape at the top or bottom of the button to scroll up or down a page. When you have reached the desired section of the page, release the button. (Figure 2-16)

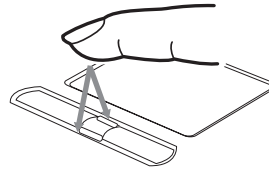

Figure 2-16 Scrolling

OPTIONAL QUICK POINT FEATURE

The optional Quick Point device consists of a cursor control button at the lower center of the keyboard. It is roughly the same size and shape as a pencil eraser. The cursor control works the same way a mouse ball does, and moves the cursor around the display. It only requires light pressure to move; the more pressure you use, the faster the cursor will move.

When used with the Quick Point button, the middle Touchpad button allows you to scroll up and down a screen.

Volume Control

Your Fujitsu LifeBook notebook has multiple volume controls which interact with each other.



Any software that contains audio files will also contain a volume control of its own. If you install an external audio device that has an independent volume control, the hardware volume control and the software volume control will interact with each other. It should be noted that if you set your software volume to Off, you will override the external volume control setting.

CONTROLLING THE VOLUME

The volume can be controlled in several different ways:

- Volume can be set from within the Volume Control on the Taskbar.
- Volume can be controlled with the F8 and F9 functions keys. Pressing [F8] repeatedly while holding [Fn]

will decrease the volume of your notebook. Pressing [F9] repeatedly while holding [Fn] will increase the volume of your notebook.



There are 26 levels through which the function keys cycle.

- Volume can be controlled by many volume controls that are set within individual applications.
- Certain external audio devices you might connect to your system may have hardware volume controls.

Each source discussed above puts an upper limit on the volume level that must then be followed by the other sources.

We recommend that you experiment with the various volume controls to discover the optimal sound level.

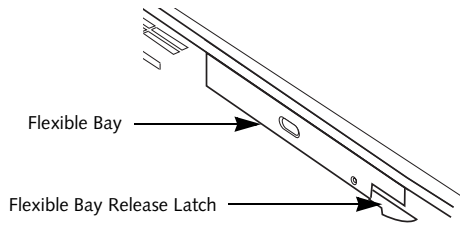

Figure 2-17 Flexible Bay

Flexible Bay Devices

Your Fujitsu LifeBook notebook contains a Flexible Bay. The Flexible Bay can house an optical drive, a Lithium ion battery, and a weight saver. (Figure 2-17)

Your Flexible Bay will have one of the following devices installed.

- **Modular Multi-Format DVD Writer:** This allows you to access movies, software, and audio DVD/CDs and record to DVD, CD, and DVD-RAM discs.
- **Modular DVD/CD-RW combo drive:** This allows you to access movies, software, and audio DVD/CDs as well as to write to CDs.
- **Modular DVD-ROM drive:** This allows you to access software, data, video, or audio CDs and DVDs.
- **Modular Lithium ion battery:** This is a rechargeable battery that can be used to power your LifeBook notebook when an adapter is not connected.
- **Weight Saver:** This is used to fill the bay when no device is needed.

REMOVING AND INSTALLING MODULAR DEVICES

There are two ways to remove and install modular devices in the Flexible Bay:

- **Cold-swapping:** swapping devices while your LifeBook notebook is powered off.
- **Hot-swapping:** swapping devices while your system is active using the Unplug/Eject icon from your taskbar.



You should never leave your Flexible Bay empty when the notebook is in operation. If left empty, dust or foreign matter may accumulate inside the notebook.

Cold-swapping

To cold-swap modular devices in your Flexible Bay follow these easy steps: (Figure 2-18)

1. Close any open files.
2. Shut down your LifeBook notebook.

3. Pull out the Flexible Bay release latch. This will push your device out slightly, allowing you to remove it.
4. Slide your device out until it is clear of the bay. This will require light force.

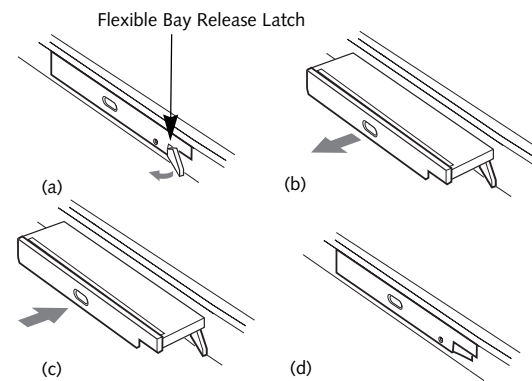

Figure 2-18 Removing/Installing a device in the Flexible Bay



Be careful when aligning and seating devices in the bay. If the fit is incorrect, you may damage the bay or the device. If the device does not move easily in the bay, remove it, and check for dirt or foreign objects. It will require a firm push to latch the device in place.

5. Slide the device you are installing into your notebook until it clicks into place.
6. It is now safe to turn your notebook back on.
7. You can now access and use the device.

Your LifeBook notebook will automatically detect the new device and activate it within your system. The drive letters associated with the device will be created and listed under My Computer and Windows Explorer.

Hot-swapping

Under Windows XP, hot-swapping is provided through the Unplug or Eject Hardware utility.

The icon for the utility appears on the taskbar. Click on the icon and follow the on-screen instructions.

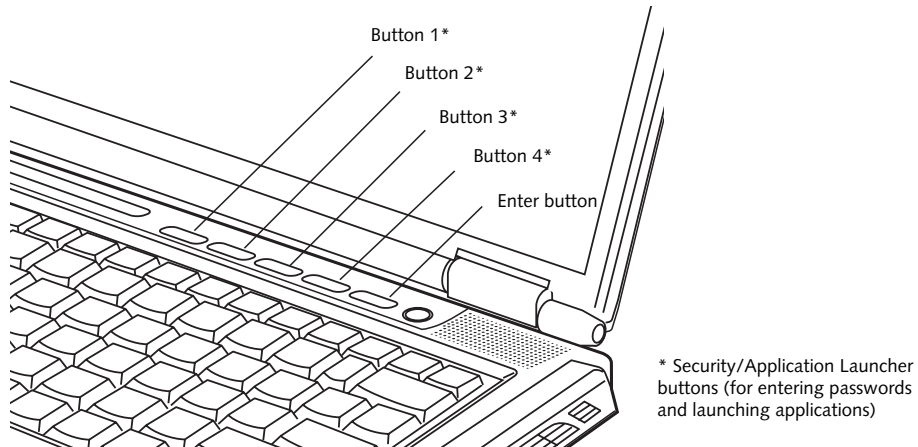

Figure 2-19 LifeBook Security/Application Panel

* Security/Application Launcher buttons (for entering passwords and launching applications)

LifeBook Security/ Application Panel

A unique feature of your LifeBook notebook is the Security/Application Panel that allows you to secure your notebook from unauthorized use. The Security/Application Panel also allows you to launch applications with the touch of a button when your system is on.

If the security system is activated, upon starting your notebook or resuming from suspend mode the security system requires you to enter a password code using the buttons on the Security/Application Panel. After entering a correct password, your notebook resumes system operation. (Figure 2-19)

SETTING UP YOUR LIFEBOOK SECURITY PANEL

When you receive your LifeBook notebook, the security panel application is pre-installed without any passwords. The following sections provide detailed information on your security panel, and how to set, change or remove passwords.

Numbered Buttons

Use these buttons to enter your password. (Figure 2-19)

Enter Button

After entering the button strokes, push this button to enter the password into the LifeBook notebook. (Figure 2-19)

PASSWORDS

The user and supervisor password may be set on this notebook. A supervisor password is typically the same for all LifeBook notebooks in a working group, office, or

company to allow for system management. Individual LifeBook notebooks in a group environment should not use a common password. A password consists of one to five button strokes plus the enter button. A valid stroke consists of pushing one or up to four buttons simultaneously. The following are valid button strokes:

- Pushing [4] by itself
- Pushing [2] and [3] at the same time
- Pushing [1], [2], and [4] at the same time
- Pushing [1], [2], [3], and [4] at the same time

The following are valid passwords. The numbers within braces ({ }) are button strokes using more than one button.

- { [2]+[3] }, [1], [enter]
- [4], [enter]
- { [1]+[3] }, { [2]+[3]+[4] }, [1], [4], [2], [enter]

Setting Passwords

When shipped from the factory, no passwords are set. You have a choice of having no password or setting a supervisor and user password. You must set the supervisor password before the user password.



- The purpose of supervisor password is to be able to bypass the user password in case the user password is forgotten. The supervisor password alone will not lock the system.
- You have to set both the supervisor and user passwords for the security panel to work.

Setting Supervisor Password

You must have set a supervisor password before setting any user passwords. The supervisor password can bypass the user password.

1. Go to the **Start** menu.
2. Click on **Run**.
3. Type in:
C:\Program Files\Fujitsu\
Security Panel Application\
Supervisor\FJSECS.EXE,
then press [Enter]
4. Follow the on-screen instructions to set the Supervisor password.

Setting User Password

1. Go to the **Start** menu.
2. Click on **Programs**.
3. Click on **Security Panel Application and Set User Password**.
4. Follow the on-screen instructions to set the user password.



You may change or remove the supervisor or user password by repeating the steps defined above.

OPERATING YOUR LIFEBOOK SECURITY/ APPLICATION PANEL

The security lock feature is in effect both when the system resumes from Off or suspend state. You always need to push the Suspend /Resume button to input the user password. Your system will not begin the boot sequence without entering your supervisor/user password.

From Off State

1. Turn on your system.
2. When the Security Indicator flashes, enter the password and press Enter button.

For example, if the password is 22222, Press Button Number 2 five times and press Enter button.

The LifeBook notebook will boot to normal operation.

From Suspend State

1. Press your Power/Suspend/Resume button.
2. When the Security Indicator flashes, enter the password and press Enter button.

The notebook should resume normal operation.

Incorrect Password Entry

If an invalid supervisor or user password is entered three times in succession, the system will “beep” for about one minute. If a valid password is entered within a minute (while system beeps), the beeping will stop and the notebook will resume normal operation. If no password (or

an invalid one) is entered while the system beeps, the system will return to its previous locked state (suspend or off) and the Security Indicator will go off. To reactivate the notebook after a password failure, you must press the Power/Suspend/Resume button, then enter a correct password.



Remember the user password you specified on the Security Panel Application. If you forget the password you will not be able to use your computer. The supervisor password can override the user password.

PRECAUTIONS

Opening and Closing the Cover

Closing the cover automatically places the notebook into suspend mode. Opening the cover does not automatically place the notebook into normal operation. Instead, you must enter the proper security password after pushing the Power/Suspend/Resume button.

Low Battery Operations

If your LifeBook notebook has low battery, pushing the Power/Suspend/Resume button only turns on the Security Indicator. Your notebook does not unlock, the Security Indicator turns off after one minute. To resume normal operation, first attach a power supply to the notebook. Then you may unlock the notebook.

UNINSTALLING THE SECURITY PANEL APPLICATION

You have two options when uninstalling the security panel application:

- Uninstall the security panel application software. This will disable all security feature.
- Uninstall the security panel application with password still active. This will not allow any changes to the password.

Uninstalling the Security Panel Application Software

Remove passwords when User wants no password protection whatsoever and doesn't want to give anybody the utility to set a password on their computer. In this case, if passwords (supervisor, user, or both) are set, the passwords must first be cleared BEFORE removing the application. To clear passwords, follow same procedure in SETTING PASSWORD CODES except this time, select REMOVE, enter current password then click Next. When asked to confirm select Yes.

Removing Security Panel Application with Passwords Still Active

Using this feature will not allow any changes to the password.



Removing the applications does not remove the password. It simply removes the utility to change/add/remove passwords. To change your password you must reinstall the application.

User:

1. Go to **Start Menu**, Click on **Control Panel**.
2. Open **Add/Remove Programs Properties** in the Control Panel.
3. Select the **Security Panel Application** in the list, and click **Add/Remove**.
4. When the **Confirm File Deletion** box appears, click **Yes**.

Supervisor:

1. Go to **Start Menu**, Click on **Control Panel**.
2. Open **Add/Remove Programs Properties** in the Control Panel.
3. Select the **Security Panel Application for Supervisor** in the list, and click **Add/Remove**.
4. When the **Confirm File Deletion** box appears, click **Yes**.

Reinstalling the Security/Application Panel

To reinstall supervisor or user security application, you will need your Drivers and Applications CD. The **Utilities/Security Application Panel** folder contains two separate folders: **Supervisor** and **User**. The setup files for supervisor and user security applications are contained in those folders.

1. Go to the **Utilities/Security Application Panel/Supervisor** folder on the CD and double-click the **setups.exe** file. The **Installing Security Panel Application** window will appear. Follow the instructions on the screen.
2. Go to the **Utilities/Security Application Panel/User** folder on the CD and double-click the **setup.exe** file. The **Installing Security Panel Application** window will appear. Follow the instructions on the screen.

Supervisor and user passwords can be set via Windows software using the **FJSECS.exe** and **FJSECU.exe** files, respectively. **FJSECU.exe** for the user password cannot run without first setting a supervisor password. You need to run **FJSECS.exe** first to set the supervisor password. Follow instructions under **Setting Passwords** on page 20.

If you forget both passwords, please contact Fujitsu Computer Systems Corporation Service and Support at 1-800-8FUJITSU (1-800-838-5487). Fujitsu Computer Systems Corporation charges a service fee for unlocking a password restricted LifeBook notebook. When calling please have a valid credit card and provide proof of ownership. You will then be given instructions on where to ship your notebook.

LAUNCHING APPLICATIONS WITH THE SECURITY/APPLICATION PANEL

The security panel also enables you to launch applications with the touch of a button when your system is on.

Pressing any of the buttons will launch a user-defined application. Your notebook is pre-installed with software utilities that let you operate and configure your LifeBook Security /Application Panel. These utilities are found in the Start menu, under Settings -> Control Panel -> Application Panel. (For Windows XP users, go to Start -> Control Panel -> Other Control Panel Settings -> Application Panel. They include two Application Panel Setup tabs, E-mail Setup, and Internet Setup.

Configuring your LifeBook Application Panel

When you start Windows, the LifeBook Application Panel is automatically activated. An icon resembling a finger pressing a button will appear on the system tray (the indented portion of the status bar where the clock is displayed). When you see this icon you will know that LifeBook Application Panel is active.

As an application launcher, the LifeBook Application Panel is very flexible, giving you a variety of options. To set up the Panel to best suit your needs, we have provided the Application Panel Setup utility that quickly and easily helps you make the most of this valuable feature.

To configure your LifeBook Application Panel with Application Panel Setup:

1. Click on **Start**.
2. Click on **Programs**.
3. Click on **LifeBook Application Panel**.
4. Click on **Application Panel Setup**.

The Application Panel Setup utility will appear. There are tabs that correspond to the application buttons on the LifeBook Application Panel. When you receive your notebook, these buttons are pre-configured to launch specific programs, as referenced in Chapter 7 of this document.



The tabs in Application Panel Setup may not be in the same order as the buttons on your LifeBook notebook, please select the tab you wish to change carefully.

To change an application associated with the Application buttons, click on the tab for the button you would like to reconfigure – for example, Application A. Click on Browse from Start Menu, scroll down the list of applications, click on the application you wish to launch with this button, and then click OK. The button will now launch the new application.

The Internet tab is different. It comes set to launch your Windows default Internet browser (Internet Explorer), unless you have changed this in Windows. In order to reconfigure it to launch another program follow these easy steps:

1. Click on **Other** from the Internet browser box.
2. Click on **Browse** from Start Menu.
3. Scroll down the list of applications, and then click on the application you wish to launch with this button.
4. Click **OK**.

The button will now launch the new application. If you want to return to launching your Windows default Internet browser with this button, you need only click on “Default Internet Browser” from the Internet browser box. Be aware that you will erase the settings for the “other application”. If you wish to go back to launching the “other application” from this button, you will need to reconfigure it as described above.



If your system has dedicated one of the application launcher buttons to be an Internet launcher, the button can still be configured to launch any application you wish, not just an Internet browser.

When you have finished with Application Panel Setup click OK, and the new settings will take effect. You can reconfigure your LifeBook Application Panel as often as you like.

Deactivating and Activating the LifeBook Application Panel

To deactivate the LifeBook Application Panel, follow these easy steps:

1. Click on **Start**.
2. Click on **Programs**.
3. Click on **LifeBook Application Panel**.
4. Click on **Deactivate Panel**.

To reactivate, follow the same procedure, except for step 4. Click on **Activate Panel** instead.



Every time you start Windows the LifeBook Application Panel is activated, even if you deactivated it before you shut down.



3

Getting Started

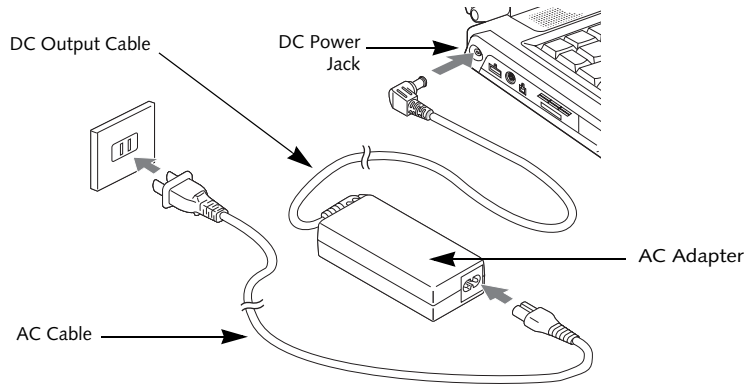

Figure 3-1 Connecting the AC Adapter

Power Sources

Your Fujitsu LifeBook notebook has three possible power sources: a primary Lithium ion battery, an AC adapter or an optional Auto/Airline adapter.

CONNECTING THE POWER ADAPTERS

The AC adapter or optional Auto/Airline adapter provides power for operating your notebook and charging the batteries.

Connecting the AC Adapter

1. Plug the DC output cable into the DC power jack of your LifeBook notebook.
2. Plug the AC adapter into an AC electrical outlet. (Figure 3-1)

Connecting the Optional Auto/Airline Adapter

1. Plug the DC output cable into the DC power jack on your notebook.

2. Plug the Auto/Airline adapter into the cigarette lighter of an automobile with the ignition key in the On or Accessories position.
OR
3. Plug the Auto/Airline adapter into the DC power jack on an airplane seat.

Switching from AC Adapter Power or the Auto/Airline Adapter to Battery Power

1. Be sure that you have at least one charged battery installed.
2. Remove the AC adapter or the Auto/Airline adapter.



The Lithium ion battery is not charged upon purchase. Initially, you will need to connect either the AC adapter or the Auto/Airline adapter to use your notebook.

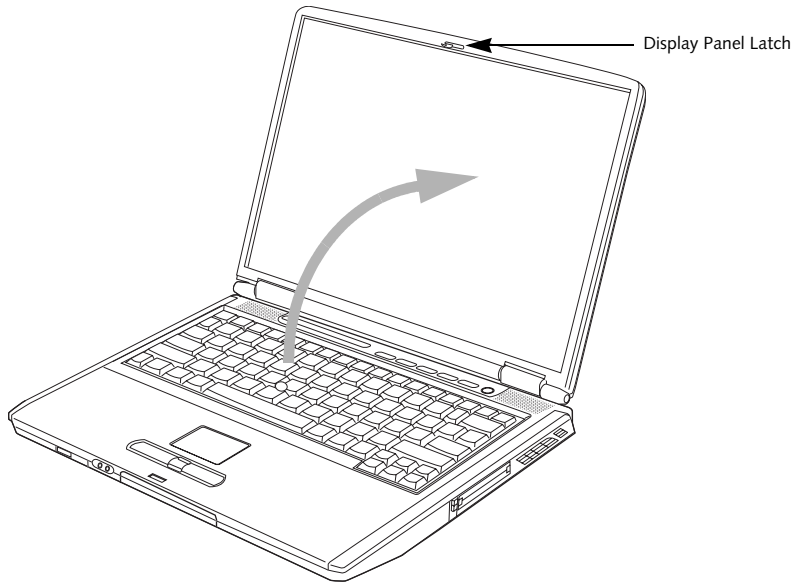

Figure 3-2 Opening the Display Panel

Display Panel

Your Fujitsu LifeBook notebook contains a display panel that is backlit for easier viewing in bright environments and maintains top resolution through the use of active-matrix technology.

OPENING THE DISPLAY PANEL

1. Push the Display Panel latch to the right. This releases the locking mechanism, allowing you to raise the display.
2. Lift the display backwards, being careful not to touch the screen, until it is at a comfortable viewing angle. (Figure 3-2)

ADJUSTING DISPLAY PANEL BRIGHTNESS

Once you have turned on your LifeBook notebook, you may want to adjust the brightness level of the screen to a more comfortable viewing level. There are two ways to adjust the brightness, by using the keyboard or the power management utility.

Using the Keyboard

Adjusting the brightness using the keyboard changes the setting only temporarily.

- [Fn+F6]: Pressing repeatedly will lower the brightness of your display.
- [Fn+F7]: Pressing repeatedly will increase the brightness of the display.



- When using AC power your brightness setting is set to its highest level by default. When using battery power your brightness setting is set to approximately mid-level by default.
 - The higher the brightness level, the more power the notebook will consume and the faster your batteries will discharge. For maximum battery life, make sure that the brightness is set as low as possible.
-
-

CLOSING THE DISPLAY PANEL

1. Holding the edge of your display panel, pull it forward until it is flush with the body of your LifeBook notebook.
2. Push down until you hear a click. This will engage the locking mechanism and prevent your display panel from opening unexpectedly.

Starting Your LifeBook Notebook

POWER ON

Power/Suspend/Resume Button

The Power/Suspend/Resume button is used to turn on your LifeBook notebook from its off state. Once you have connected your AC adapter or charged the internal Lithium ion battery, you can power on your LifeBook notebook. (See figure 2-3 on page 6 for location)



When you turn on your LifeBook notebook be sure you have a power source. This means that at least one battery is installed and charged, or that the AC or Auto/Airline adapter is connected and has power.

To turn on your LifeBook notebook from its off state, press the Power/Suspend/Resume button, located above the keyboard. When you are done working you can either leave your LifeBook notebook in Suspend mode, (See *Suspend Mode on page 32 for more information*), or you can turn it off (See *Power Off on page 33 for more information*).



Do not carry your LifeBook notebook around with the power on or subject it to shocks or vibration, as you risk damaging your notebook.

When you power on your LifeBook, it will perform a Power On Self Test (POST) to check the internal parts and configuration for correct functionality. If a fault is found, your LifeBook notebook will emit an audio warning and/or an error message will be displayed. (See *Power On Self Test Messages on page 62 for more information*)

Depending on the nature of the problem, you may be able to continue by starting the operating system or by entering the BIOS setup utility and revising the settings.

After satisfactory completion of the Power On Self Test (POST), your notebook will load your operating system.



Never turn off your LifeBook notebook during the Power On Self Test (POST) or it will cause an error message to be displayed when you turn your LifeBook notebook on the next time. (See *Power On Self Test Messages on page 62 for more information*)

BOOT SEQUENCE

The procedure for starting up your notebook is called the Bootup sequence and involves your notebook's BIOS. When your LifeBook notebook is first turned on, the main system memory is empty, and it needs to find instructions to start up your notebook. This information is in the BIOS program. Each time you power up or restart your notebook, it goes through a boot sequence which displays a Fujitsu logo until your operating system is loaded. During booting, your notebook is performing a standard boot sequence including a Power On Self Test (POST). If the sequence is completed without a failure and without a request for the BIOS Setup Utility, the system displays the operating system's opening screen.

The boot sequence is executed when:

- You turn on the power to your LifeBook notebook.
- You restart your notebook from the Windows Shut Down dialog box.
- The software initiates a system restart. Example: When you install a new application.
- You reset the system by pressing [CTRL+ALT+DEL].

BIOS SETUP UTILITY

The BIOS Setup Utility is a program that sets up the operating environment for your LifeBook notebook. Your BIOS is set at the factory for normal operating conditions, therefore there is no need to set or change the BIOS' environment to operate your notebook.

The BIOS Setup Utility configures:

- Device control feature parameters, such as changing I/O addresses and boot devices.
- System Data Security feature parameters, such as passwords.

Entering the BIOS Setup Utility

To enter the BIOS Setup Utility do the following:

1. Turn on or restart your LifeBook notebook.
2. Press the [F2] key when the Fujitsu logo appears on the screen. This will open the main menu of the BIOS Setup Utility with current settings displayed.
3. Press the [RIGHT ARROW] or [LEFT ARROW] key to scroll through the other setup menus to review or alter the current settings.

BIOS Guide

A guide to your notebook's BIOS is available online. Please visit our service and support Web site at <http://www.computers.us.fujitsu.com/support>. Once there, select Support, then select Notebooks under User's Guides. Select LifeBook BIOS Guides from the pull-down menu for your LifeBook series. If you are unsure of your notebook's BIOS number, refer to your packing slip.



If your data security settings require it, you may be asked for a password before the BIOS main menu will appear.

BOOTING THE SYSTEM

We strongly recommend that you do not attach any external devices and do not put a DVD/CD in any drive until you have gone through the initial power on sequence.

When you turn on your LifeBook notebook for the first time, it will display a Fujitsu logo on the screen. If you do nothing, the system will load the operating system, and then the Windows Welcome will begin.

Designed to accommodate the needs of users in many different countries, Windows needs to be configured the first time you use it. Windows has three parts:

- **Getting Started:** You have the opportunity to enter custom information for your configuration file and setup your modem so that your LifeBook notebook will be prepared to dial out.
- **Registration:** Easy online registration for Windows with Microsoft, and for your LifeBook notebook with Fujitsu.
- **Windows License Agreement and Final Settings:** You have the opportunity to review the Windows.

Getting Started

Read the instructions on the screens carefully and fill in the information as directed. You will be asked for such items as the language you wish to use, the country in which you live, your first and last name, and how you dial out from where you will be using your notebook. For the modem settings, enter your current location information where you will be using your notebook. If you are not connected to a phone line and plan to register at a later time, you may click the **Skip** button, and you will go directly to the condition of use page.



Make sure you have connected a phone line to your modem before you use E-Registration.

Once you have set up your notebook to dial out, Windows will make a free telephone call which will test these settings. If the call is unsuccessful, you will be returned to the phone settings page where you may try to fix them. If you are unable to fix the settings please contact Fujitsu Service and Support. (*See Fujitsu Contact Information on page 1 for more information*) If you would simply like to move on, and register at a later time, you may click the **Skip** button, and you will go directly to the Condition of Use page.

Registration

If your connection is successful, you will go to the Registration Confirmation page. On this page simply enter the requested information, and then check the box at the bottom to register your copy of Windows with Microsoft. Once you have finished, click the **Next** button to continue.



If you do not register at this time you can do it later simply by double-clicking on the **LifeBook Registration** icon on your desktop and following the instructions.

You will then go through the Fujitsu registration process. Follow the instructions on the screens, and enter all of the necessary information. Be as specific as possible so that if you need help the service and support team will be able to serve you better.

Final Settings

The first part of your final settings is the Windows End User License Agreement. Read the agreement carefully. When you finish reading you must accept or reject the terms of the agreement and then click on the **Next** button.



If you reject the terms of the license agreement you will be asked to review the license agreement for information on returning to Windows or to shut down your LifeBook notebook.

WINDOWS PRODUCT ACTIVATION

Your system has Windows XP as an operating system, and it has already been pre-installed and pre-activated when you receive the system.

In the event you need to re-install Windows XP (e.g., after making significant configuration changes), it may be necessary to reactivate the operating system. To do so, use the following information.

- After re-installing Windows XP, you have 30 days to activate it. Activation ensures that you are the authorized owner of the Windows XP operating system.
- Until you activate the product, you will be prompted whenever you turn on the system that activation is required. Follow the on-screen directions to activate your operating system. The product only needs to be activated once, unless significant hardware changes are made to your system.
- Note that Product Activation and Registration are not the same thing. Registration is optional, whereas Product Activation is a required procedure.

REGISTERING YOUR LIFEBOOK NOTEBOOK

How do I register?

To register, visit our Web site at:

<http://www.computers.us.fujitsu.com>

INSTALLING CLICK ME!

The first time you boot up your system, you will see an icon called Click Me! in the Start menu. When you click the Click Me! icon, your system will automatically build the icon tray in the bottom right of the screen. These icons provide links to utilities that you will frequently access.

Click Me! will install additional system utilities to maximize the performance of your system.

Power Management

Your Fujitsu LifeBook notebook has many options and features for conserving battery power. Some of these features are automatic and need no user intervention, such as those for the internal modem. However, others depend on the parameters you set to best suit your operating conditions, such as those for the display brightness. Internal power management for your notebook may be controlled from settings made in your operating system, pre-bundled power management application, or from settings made in BIOS setup utility.

Besides the options available for conserving battery power, there are also some things that you can do to prevent your battery from running down as quickly. For example, you can create an appropriate power saving profile, put your notebook into Suspend mode when it is not performing an operation, and you can limit the use of high power devices. As with all mobile, battery powered computers, there is a trade-off between performance and power savings.

POWER/SUSPEND/RESUME BUTTON

When your notebook is active, the Power/Suspend/Resume button can be used to manually put the notebook into Suspend mode. Push the Power/Suspend/Resume button when the notebook is active, but not actively accessing anything, and immediately release the button. You will hear two short beeps and the system will enter Suspend mode.

If your notebook is suspended, pushing the Power/Suspend/Resume button returns your notebook to active operation. You can tell whether the system is Suspended by looking at the Power indicator. (See *Figure 2-3 on page 6*) If the indicator is visible and not flashing, your notebook is fully operational. If the indicator is visible *and* flashing, your notebook is in Suspend mode. If the indicator is not visible, the power is off or your notebook is in Hibernation mode. (See *Hibernation Feature*)

SUSPEND MODE

Suspend or Standby mode in Windows saves the contents of your system memory during periods of inactivity by maintaining power to critical parts. This mode will turn off the CPU, display, hard drive, and all the other internal components except those necessary to maintain system memory and allow for restarting. Your notebook can be put in Suspend mode by:

- Pressing the Power/Suspend/Resume button when your system is turned on.
- Selecting Standby from the Windows Shut Down menu.
- Timing out from lack of activity.
- Allowing the battery to reach the Dead Battery Warning condition.

Your notebook's system memory typically stores the file on which you are working, open application information, and any other data required to support operations in progress. When you resume operation from Suspend mode, your notebook will return to the point where it left off. You must use the Power/Suspend/Resume button to resume operation, and there must be an adequate power source available, or your notebook will not resume.

-
-
- If you are running your notebook on battery power, be aware that the battery continues to discharge while your notebook is in Suspend mode, though not as fast as when fully operational.
 - Disabling the Power/Suspend/Resume button prevents it from being used to put the notebook into Suspend or Hibernation (Save-to-Disk) mode. The button resume function cannot be disabled.
 - The Suspend or Hibernation (Save-to-Disk) mode should not be used with certain PC Cards. Check your PC Card documentation for more information. When PC Cards or external devices are in use, Hibernation (Save-to-Disk) mode cannot return to the exact state prior to suspension, because all of the peripheral devices will be re-initialized when the system restarts.
 - If your notebook is actively accessing information when you enter the Suspend or Hibernation (Save-to-Disk) mode, changes to open files are not lost. The files are left open and memory is kept active during Suspend mode or the memory is transferred to the internal hard drive during Hibernation mode.



The main advantage of using Hibernation (Save-to-Disk) is that power is not required to maintain your data. This is particularly important if you will be leaving your notebook in a suspended state for a prolonged period of time. The drawback of using Hibernation mode is that it lengthens the power down and power up sequences and resets peripheral devices.

HIBERNATION (SAVE-TO-DISK) FEATURE

The Hibernation feature saves your system's memory contents to the hard drive as a part of the Suspend/Resume mode. You can enable or disable this feature.

Enable or Disable the Hibernation Feature

The default settings is not enabled. To enable or disable the Hibernation feature follow these easy steps:

1. From the **Start** menu, select **Settings**, and then select **Control Panel**.

2. From the Control Panel select **Power Options**.
3. Select the **Hibernation** tab. Select the box to enable or disable this feature.

Using the Hibernation Feature

1. From the **Start** menu, select **Settings**, and then select **Control Panel**.
2. From the Control Panel select **Power Options**.
3. Select the **Advanced** tab. Select **Hibernate** from the pull down menu for Power buttons.

DISPLAY TIMEOUT

The Video Timeout is one of the power management parameters. This feature saves power by turning off the display if there is no keyboard or pointer activity for the user selected timeout period. Any keyboard or pointer activity will cause the display to restart automatically. This feature is independent of the Power/Suspend/Resume button and can be enabled and disabled in Windows and BIOS setup utility. (See *BIOS Setup Utility on page 29 for more information*)

HARD DISK TIMEOUT

The Hard Disk Timeout is another one of the power management parameters. This feature saves power by turning off the hard drive if there is no hard drive activity for the user selected timeout period. Any attempt to access the hard drive will cause it to restart automatically. This feature is independent of the Power/Suspend/Resume button and can be enabled and disabled in Windows and BIOS setup utility. (See *BIOS Setup Utility on page 29 for more information*)

WINDOWS POWER MANAGEMENT

Power Management

The Power Management icon located in the Windows Control Panel allows you to configure some power management settings. For example, you can use Power Management to set the timeout values for turning off the display and hard disks whether you are running the notebook on battery power or one of the adapters. The settings may also be changed in the BIOS. (See *BIOS Setup Utility on page 29 for more information*)

RESTARTING THE SYSTEM

If your system is on and you need to restart it, be sure that you use the following procedure.

1. Click the **Start** button, and then click **Shut Down**.
2. Select the **Restart** option from within the Windows Shut Down dialog box.
3. Click **OK** to restart your notebook. Your notebook will shut down and then reboot.



Turning off your notebook without exiting Windows, or turning it on within 10 seconds of being shut off may cause an error when you start the next time.

POWER OFF

Before turning off the power, check that the hard drive, optical drive, PC Card, and floppy disk indicators are all Off. (See *Figure 2-3 on page 6*). If you power-off while accessing a disk or PC Card there is a risk of data loss. To ensure that the notebook shuts down without error, use the Windows shutdown procedure.



Be sure to close all files, exit all applications, and shut down your operating system prior to turning off the power. If files are open when you turn the power off, you will lose any changes that have not been saved, and may cause disk errors.

Using the correct procedure to shut down from Windows allows your notebook to complete its operations and turn off power in the proper sequence to avoid errors. The proper sequence is:

1. Click the **Start** button, and then click **Shut Down** or **Turn Off Computer**.
2. Select the **Shut Down** option from within the Windows Shut Down dialog box.
3. Click **OK** to shut down your notebook.

If you are going to store your notebook for a month or more see Care and Maintenance Section.



4

User-Installable Features

Lithium ion Battery

Your LifeBook notebook has a Lithium ion battery that provides power for operating your notebook when no external power source is available. The battery is durable and long lasting, but should not be exposed to extreme temperatures, high voltages, chemicals or other hazards.

The Lithium ion battery operating time may become shorter if it is used under the following conditions:

- When used at temperatures that exceeds a low of 5°C or a high of 35°C. Extreme temperatures not only reduce charging efficiency, but can also cause battery deterioration. The Charging icon on the Status Indicator panel will flash when you try to charge a battery that is outside its operating temperature range. (See *Battery Charging Indicators on page 13 for more information*)
- When using a high current device such as a modem, Multi-Format DVD Writer, CD-ROM drive, DVD/CD-RW combo drive, or the hard drive, using the AC adapter will conserve your battery life.



Do not leave a faulty battery in your LifeBook notebook. It may damage your AC adapter, optional Auto/Airline adapter, another battery or your notebook itself. It may also prevent operation of your notebook by draining all available current into the bad battery.



- Actual battery life will vary based on screen brightness, applications, features, power management settings, battery condition and other customer preferences. CD-ROM drive, Multi-Format DVD Writer, DVD/CD-RW drive combo, or hard drive usage may also have a significant impact on battery life. The battery charging capacity is reduced as the battery ages. If your battery is running low quickly, you should replace it with a new one.
- Under federal, state, or local law it may be illegal to dispose of batteries by putting them in the trash. Please take care of our environment and dispose of batteries properly. Check with your local government authority for details regarding recycling or disposing of old batteries. If you cannot find this information elsewhere, contact your support representative at 1-800-8FUJITSU (1-800-838-5487)

RECHARGING THE BATTERIES

If you want to know the condition of the primary Lithium ion battery, check the Battery Level indicator located on the Status Indicator panel. The indicator changes as the battery level changes.

The Lithium ion battery is recharged internally using the AC adapter or Auto/Airline adapter. To recharge the battery make sure the battery that needs to be charged is installed in your LifeBook notebook and connect the AC or Auto/Airline adapter.



Make sure that the Battery Charging indicator and the percentage charge is shown inside the Battery Level icon on the Status Indicator Panel.

There is no memory effect on the Lithium ion battery therefore you do not need to discharge the battery completely before recharging. The charge times will be significantly longer if your notebook is in use while the battery is charging. If you want to charge the battery more quickly, put your notebook into Suspend mode, or turn it off while the adapter is charging the battery. (See *Power Management on page 32 for more information on Suspend mode and shutdown procedure*)



Using heavy current devices such as Modem or frequent DVD/CD-RW/CD-ROM accesses may prevent charging completely.

Low Battery State

When the battery is running low, a low battery notification message will appear. If you do not respond to the low battery message, the batteries will continue to discharge until they are too low to operate. When this happens, your notebook will go into Suspend mode. There is no guarantee that your data will be saved once the notebook reaches this point.



- Once the low battery notification message appears, you need to save all your active data and put your LifeBook notebook into Suspend mode until you can provide a new power source. You should provide a charged battery, an AC power adapter, or Auto/Airline adapter as soon as possible.
- When you are in Suspend mode there must always be at least one power source active. If you remove all power sources while your LifeBook notebook is in Suspend mode, any data that has not been saved to the hard drive will be lost.

Dead Battery Suspend mode shows on the Status indicator just like the normal Suspend mode. Once your notebook goes into Dead Battery Suspend mode you will be unable to resume operation until you provide a source of power either from an adapter, or a charged battery. Once you have provided power, you will need to press the Power/Suspend/Resume button to resume operation.

In the Dead Battery Suspend mode, your data can be maintained for some time, but if a power source is not provided promptly, the Power indicator will stop flashing and go out, meaning that you have lost the data that was not stored. Once you provide power, you can continue to use your notebook while an adapter is charging the battery.

Shorted Batteries

The Status Indicator panel uses a symbol inside the battery outline of the Battery Level indicator to display the operating level available in that battery. (See figure 2-10 on page 12) If this display shows a Shorted Battery, it means the battery is damaged and must be replaced so it does not damage other parts of your LifeBook notebook.

REPLACING THE BATTERY

With the purchase of an additional battery, you can have a fully charged spare to swap with one that is not charged. There are two ways to swap batteries, cold-swapping and hot-swapping:

Cold-swapping Batteries

To cold-swap batteries in your battery bay follow these easy steps: (Figure 4-1)

1. Have a charged battery ready to install.
2. Shut down your notebook and disconnect the AC adapter.
3. Unlock the battery by pushing the two release latches toward the battery pack (Figure 4-1).
4. While pressing the release latches, lift the battery out of the bay.
5. Insert a new battery into the bay, and press it down so that the latches click into place.
6. Plug in the AC adapter and turn the power on.

Hot-swapping Batteries

To hot-swap batteries in your battery bay follow these easy steps: (Figure 4-1)



Be sure to plug in an AC Adapter prior to removing the battery. There is no bridge battery present to support the system while the battery is being replaced. If you do not use an AC Adapter you will lose any unsaved files.

1. Plug an AC Adapter into the system and connect it to a power outlet.

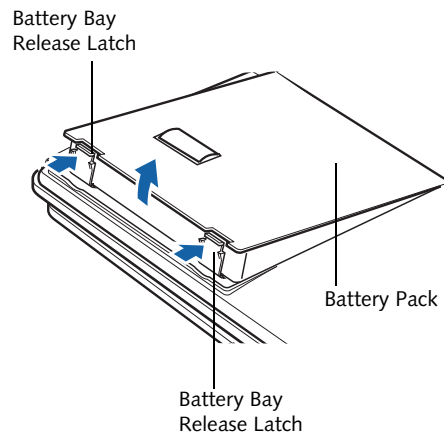

Figure 4-1. Removing a Battery

2. Follow steps 3 through 5 in “Cold Swapping Batteries”.



If the Lithium ion battery connector is not fully seated, you may not be able to use your notebook or charge your battery.

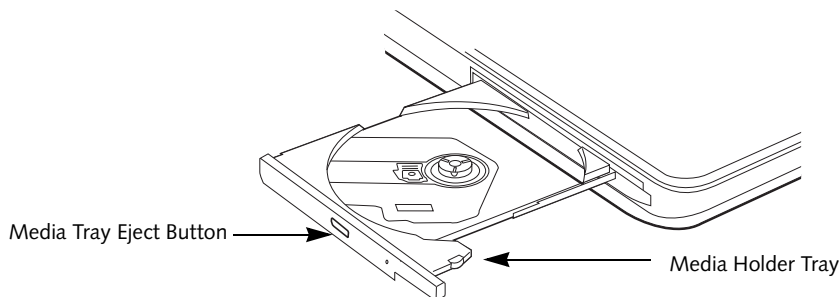

Figure 4-2. Optical Drive

Optical Drive

There is a variety of media available to use with your system, depending upon the system configuration you have selected. Multi-Format DVD Writers, DVD/CD-RW Combo drives, and DVD-ROM drives are collectively known as “optical drives”.

DVD-R and DVD-RW discs hold up to 4.7 GB of data (DVD-R discs used with the Multi-Format Dual-Layer DVD writer hold up to 8.5 GB of data.). A DVD-R disc can only be written to once; DVD-RW discs can be written to over and over. DVD-R and DVD-RW discs can be played on most standard DVD players.

CD-R and CD-RW discs hold up to 640 MB of data. A CD-R disc can only be written to once; CD-RW discs can be written to over and over.

Depending upon the configuration of your notebook, you may have one of the following optical drives:

- **DVD/CD-RW combo:** A DVD/CD-RW combo drive allows you to access movie, software, data, or audio DVD/CDs, and to write data onto recordable CD-R and CD-RW discs.
- **Dual-Layer Multi-Format DVD Writer:** This drive allows you to access movies, software, and audio DVD/CDs as well as to read and write to CD-R, CD-RW, DVD-R, DVD+R, DVD-RW, DVD+RW, and DVD RAM discs. The dual-layer architecture allows you to record up to 8.5 GB of data on DVD+R discs.
- **DVD-ROM:** A DVD-ROM drive allows you to access software, data, or audio from CDs or DVDs.



Install your media player software before first using the DVD, DVD/CD-RW, or CD-ROM media drives. Refer to the applicable readme file on the Driver Applications CD-ROM.

MEDIA PLAYER SOFTWARE

Multi-Format DVD Writer model only: With the Multi-Format DVD Writer and media player software you can play DVD movies and music CDs on your LifeBook notebook. The media player includes controls which allow you to take full advantage of the features of a DVD movie, as well as standard features such as fast forward, fast reverse, pause, etc. With this drive you can also burn onto recordable DVD-R/RW, DVD+R/RW, or CD-R/RW discs.

DVD/CD-RW Combo model only: With the combo drive, you can play DVD movies, read audio CDs, and write data onto recordable CD-R or CD-RW discs.

DVD-ROM model only: With the DVD-ROM drive, you can read software, audio, or data from CD or DVD discs.



- Do not operate your optical drive unless your LifeBook notebook is sitting on a flat surface. Using a drive when the system is not level may damage the drive or prevent proper operation.
- Prolonged use of the optical drive, such as watching a DVD movie, will substantially reduce your battery life if no other power source is attached.

LOADING MEDIA ON YOUR DRIVE

To load a disc into your optical drive:

1. Push and release the eject button on the front of the optical drive to open the holder tray. The tray will come out of the LifeBook notebook a short distance.
2. Gently pull the tray out until a media disc can easily be placed in the tray.



There may be a protective sheet in the tray from when it was shipped; please make sure it is removed before operating the drive.



- You should periodically check the Fujitsu web site at <http://www.computers.us.fujitsu.com> for current updated drivers.
- All LifeBook DVD players are set to play DVD titles with region code number 1 which is specified for the North American market. The region number is a regional restriction code defined by the DVD Forum acting on Hollywood requirements. Different region codes are recorded on video DVD titles for publication in different areas of the world. If the regional code of the DVD player does not match the regional codes on the titles, then playback is impossible.
- You can change the region code on the DVD player using the Properties menu of the DVD software. Note, however, that **you can only change the region code up to four times.** After the fourth change, the last region code entered becomes permanent, and cannot be changed.

3. Place the media into the tray, label side up, with the hole in the center of the disc. Snap the disc onto the raised circle in the center of the tray.
4. Gently push the holder tray back in until you hear a click. (Figure 4-3)



If you have disabled the Auto Insert Notification Function, you will have to start the drive from your desktop, since your LifeBook notebook will not automatically recognize that media has been loaded.

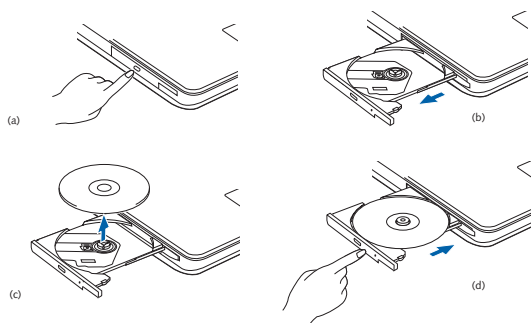

Figure 4-3. Loading/Ejecting Media

REMOVING MEDIA

1. Push and release the eject button on the front of the optical drive. This will stop the drive and the holder tray will come out of the LifeBook notebook a short distance.
2. Gently pull the tray out until the disc can easily be removed from the tray.
3. Carefully remove the media disc from the holder tray.
4. Gently push the holder tray back in until you hear a click.

USING THE MEDIA PLAYER SOFTWARE



Depending upon its configuration, your system may not have the media player software pre-installed. If it is not installed, reference the documentation that accompanies the media application.

Starting a DVD Movie (DVD Models only)

1. Insert the DVD movie into the optical drive of your notebook. If the CD AutoRun feature activates, skip Step 2.
2. The first time you insert a movie into the DVD/CD-RW tray, you will be prompted to select what you want the system to do when discs are inserted (e.g., start automatically or wait for a prompt). Until you make a selection, you will receive the same prompt whenever you insert a disc.
3. Click **OK** to close the About DVD Player Performance dialog box and the movie will begin.

Opening the Media Player Control Panel

With most DVD-ROMs, you have the option of altering how the movie should play and what you wish to view. You can do this by using the media player control panel and the mouse.

1. Right-click on the movie screen to open a dropdown menu for options.
2. Select **View**, then **Player** for all the controls available. This will open the control panel into the bottom of the screen.

Using the Media Player Control Panel

The media player software allows you to watch the movie much like a VCR player. You can pause, rewind, fast-forward and stop the movie at any point.

1. To Pause the movie, click the on-screen **II** button.
2. To Rewind the movie, click the **◀◀** button to rewind to a specific portion of the movie, or the **◀** button to return to the opening screen.

3. To Fast-forward the movie, click the ►► button to forward to a specific portion of the movie, or the►► button to jump to the ending credits.
4. To Stop the movie, click the ■ button.

Exiting the Media Player

1. Click the ✕ located in the upper right corner of the title bar. This will open a media player dialog box.
2. Click Yes to stop and exit the movie, or No to close the media player dialog box and return to the movie.

USING DOLBY™ HEADPHONE

The Dolby Headphone utility lets you enjoy multi-channel sound sources with realistic surround sound using your *conventional* stereo headphones.

Dolby Headphone is a signal processing system that enables your stereo headphones to realistically portray the sound of a five-speaker playback system.



- Media discs which do not have the Dolby Surround 5:1 symbol will not support Dolby Headphone.
- After making changes to the Dolby Headphone feature and clicking OK, wait at least ten seconds before making another change in order to allow the system to stabilize.

To use the Dolby Headphone feature, perform the following steps:

1. Insert the disc in the media player tray. When you do so, WinDVD will start automatically.
2. Click on the Fujitsu logo on the WinDVD control panel. If the disc supports Dolby Surround 5.1, a drop down menu appears.
3. Verify that Dolby headphones is checked on the menu. If you do not want it active, select Disable.

USING MEDIA PLAYER ON BATTERY POWER

Since optical drives consume a lot of power, your overall battery life will be significantly shorter when operating the optical drive continuously (such as watching a DVD movie) than during standard operation. Many movies run-times are longer than your LifeBook notebook can support on a single charged battery. If you are watching a DVD movie on battery power you may need to swap in an additional, charged battery or attach AC power during the movie to view it in its entirety.



- Prolonged use of the optical drive, such as watching a DVD movie, will greatly reduce your notebook's battery life.
- Many movie run-times are longer than your system can support on a single battery. If you are watching a DVD movie on battery power you may need to swap in an additional, charged battery or attach AC power during the movie to view it in its entirety.
- An additional fully-charged battery is highly recommended if you will be watching DVD movies on battery power. If you don't have an additional battery, you may purchase one either online at:
<http://www.computers.us.fujitsu.com> or by calling 1-877-372-3473.

To Watch a Movie on Battery Power:

1. Have an additional full-charged battery or your AC adapter ready for use.
2. Start watching your DVD movie.
3. When the low battery warning occurs, immediately stop the movie and exit the media player.



If you do not stop the media player quickly and the LifeBook notebook attempts to auto-suspend (critical battery low state) the LifeBook notebook will shut down improperly. If this occurs, you will need to perform a hard reset and follow the instruction, if any, presented to you before the system will reboot.

4. Power down your LifeBook notebook and replace the discharged battery with an additional fully-charged battery. If you do not have an additional battery, you may attach AC power as soon as you see the low battery warning.
5. Resume your LifeBook notebook by pressing the Suspend button again. This is not required if you attached AC power without entering suspend mode.
6. Restart your media player, locate and skip to the chapter of the movie you were last watching.
7. Continue watching your DVD movie.



Some shorter DVD movies may not require you to swap batteries or attach AC power to complete them. However, it is best to be prepared since actual battery life while operating the optical drive cannot be guaranteed.

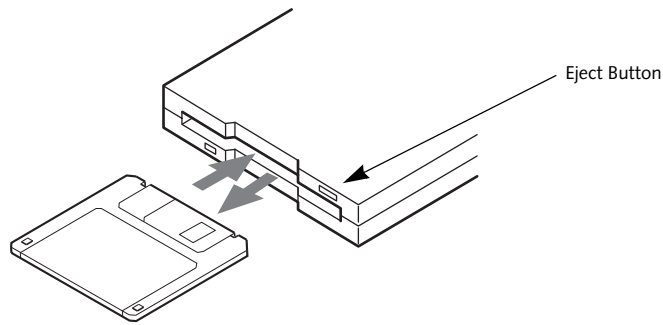

Figure 4-4. Loading/Ejecting a 3.5" Floppy Disk

External USB Floppy Disk Drive

An external USB floppy disk drive is available as an option for your LifeBook notebook. The external floppy disk drive can read and write information on removable 1.44MB and 720KB floppy disks.



Your LifeBook notebook is preconfigured to boot from a USB floppy drive. Reference the BIOS manual for further information on changing the default boot drive. The BIOS manual can be found on the Fujitsu Computer Systems web site: <http://www.computers.us.fujitsu.com>.

LOADING A DISK

To load a disk into your disk drive, follow these easy steps:

1. Orient the disk so that its label is facing upwards and the shutter side is pointing towards the drive. (Figure 4-4)
2. Push the disk into the drive until the Eject button pops out and you hear a click.



When there is no disk in the drive, the Eject button is flush with your notebook.

EJECTING A DISK

To eject a disk from the disk drive, follow these easy steps:

1. Check that the Floppy Disk Drive Access indicator is inactive.
2. Press the Eject button. This will push your disk partially out of the drive.
3. Remove the disk.



If you eject the disk while the Floppy Disk Drive Access indicator is active, there is a risk of damaging the data on the disk, the disk itself or even the disk drive.

PREPARING A DISK FOR USE

Before you can use a new disk, it needs to be prepared so your LifeBook notebook knows where to store information. This preparation is called formatting or initializing a disk. You will need to format new disks, unless they are preformatted. (Please refer to your operating system manual for step-by-step instructions on formatting a disk)

To prevent accidental erasure of the data stored on a disk, slide the "write protect" tab until a small hole is exposed. This sets the disk into a protected state where nothing can be added or removed. If you want to add or remove data on a protected disk, slide the "write protect" tab to close the small hole. (Figure 4-5)

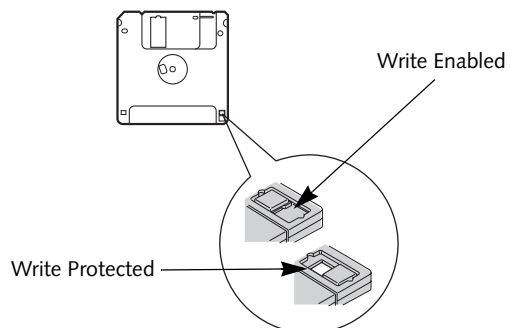

Figure 4-5. Floppy Disk Write Protect



Formatting a floppy disk that already contains data will erase all of the information on the disk.

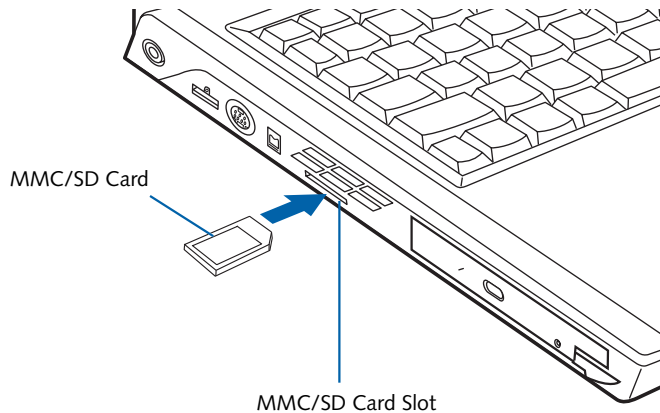

Figure 4-6. Installing a MMC/SD Card

Multimedia Card/ Secure Digital Media

Your LifeBook notebook supports Multimedia cards (MMC) and Secure Digital (SD) cards, on which you can store and transfer data to and from a variety of digital devices. These cards use flash memory architecture, which means they don't need a power source to retain data.

MMC is a flash memory technology that allows you to record, transfer and share digital content, such as digital pictures, movies, music, voice, and computer data and applications.

Secure Digital (SD) Cards are very similar to MMCs. Like the MMC, SD Cards allow portable storage among a variety of devices, such as cell phones, GPS systems, digital cameras, and PDAs. SD Cards transfer data quickly, with low battery consumption. Like the memory stick, it uses flash memory architecture.

INSTALLING MMC/SD CARDS

MMC and SD Cards are installed in the MMC/SD Card slot (Figure 4-6). To install an MMC or SD Card, follow these steps:

1. See your MMC or SD Card manual for instructions on the installation of your card. Some cards may require that your notebook is off while installing them.
2. Make sure there is no card currently in the slot. If there is, see Removing an MMC/SD Card.
3. Insert your PC Card into the slot with the product label facing up.
4. Push the card firmly into the slot until it is seated in the connector.

REMOVING AN MMC/SD CARD

To remove an MMC or SD Card, follow these easy steps:

1. See your MMC or SD Card manual for instructions on the removal of your card. Some cards may require your LifeBook notebook to be in Suspend Mode or Off while removing them.



- Installing or removing an MMC or SD Card during your LifeBook notebook's shutdown or bootup process may damage the card and/or your LifeBook notebook.
- Do not insert a card into a slot if there is water or any other substance on the card as you may permanently damage the card, your LifeBook notebook, or both.

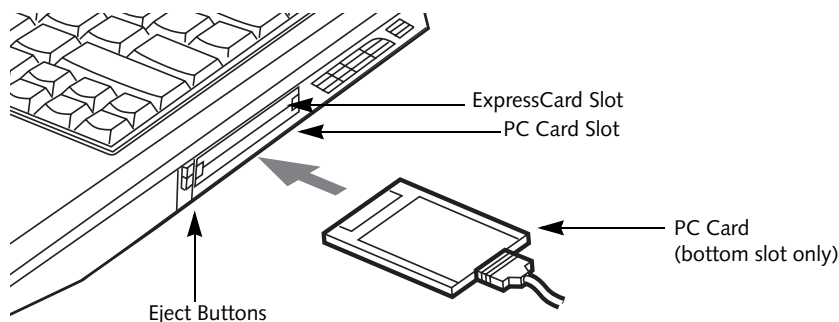

Figure 4-7. Installing/Removing PC Card

PC Cards/ExpressCards™

Your LifeBook notebook supports Type I and Type II PC Cards and ExpressCards™, which can perform a variety of functions depending on which type of card you install. You can install one or two cards at a time, depending on its type. PC Cards should be installed in the bottom slot, and ExpressCards in the top slot.

Some available PC/ExpressCards:

- Local area network (LAN) cards (Type II)
- IDE solid-state disk cards (Type II)
- SCSI cards (Type II)
- Other PC Cards that conform to PCMCIA 2.1 or CardBus standards

For further information, refer to the instructions supplied with your card(s).

INSTALLING PC CARDS

PC Cards are installed in the PC Card slot (the lower of the two slots). To install a PC Card, follow these steps:

- Installing or removing a PC Card during your LifeBook notebook's shutdown or bootup process may damage the card and/or your LifeBook notebook.
- Do not insert a PC Card into a slot if there is water or any other substance on the card as you may permanently damage the card, your LifeBook notebook, or both.



You may be required to log on as an Administrator or member of the Administrator's Group to complete this procedure. If the computer is connected to a network, network policy settings may also prevent you from completing this procedure.

1. See your PC Card manual for instructions on the installation of your card. Some cards may require that your notebook is off while installing them.

2. Make sure there is no PC Card currently in the slot. If there is, see Removing PC Cards.
3. If the eject button is extended, press it until it clicks.
4. Insert the card into the slot with the label facing up.
5. Push the card firmly into the slot until it is seated in the connector.

REMOVING PC CARDS

See your PC Card manual for specific instructions on removing your card. Some cards may require your notebook to be in Suspend Mode or Off during removal.



- Windows has a shutdown procedure for PC Cards that must be followed before removing a card. (Review your operating system manual for the correct procedure.) It is good practice to remove devices using the Unplug or Eject Hardware icon in the system tray.
- If the dialog box states that the device cannot be removed, you must save all of your open files, close any open applications and shut down your notebook.

2. Unlock the card from the slot by pressing the eject button associated with the slot in which the card is located. When pressed, the button will pop out.
3. Firmly press the button again until it is flush with the notebook. This will eject the card slightly out of the slot allowing you to remove the card.



If the PC Card has an external connector and cable, do not pull the cable when removing the card.

INSTALLING EXPRESSCARDS

There are two different width ExpressCards: 34 mm and 54 mm. The connector inside the slot is located on the left-hand side of the slot. If you insert a 34 mm card, be sure to align it with the left side of the slot when inserting it.

ExpressCards are installed in the ExpressCard slot (the top slot). (Figure 4-8).

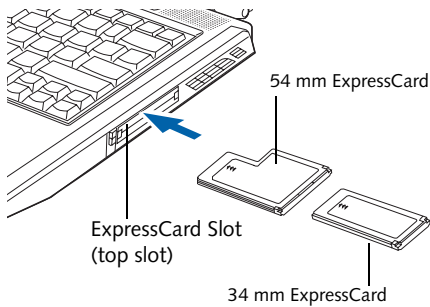

Figure 4-8. Installing/Removing ExpressCards



- Installing or removing an ExpressCard during your notebook's shutdown or bootup process may damage the card and/or your notebook.
- Do not insert an ExpressCard into a slot if there is water or any other substance on the card as you may permanently damage the card, your notebook, or both.



You may be required to log on as Administrator or a member of the Administrator's Group to complete this procedure. If your computer is connected to a network, network policy settings may also prevent you from completing this procedure.

See your ExpressCard manual for instructions on the installation of your card. Some cards may require that your notebook is off while installing them.

To install an ExpressCard, follow these steps:

1. Make sure there is no ExpressCard currently in the slot. If there is, see Removing ExpressCards.
2. If the eject button is extended, press it in until it clicks.
3. Insert your ExpressCard into the slot with the product label facing up. If you are inserting a 34 mm card, be sure to align it with the left side of the slot when inserting it.
4. Push the card firmly into the slot until it is seated in the connector.

REMOVING EXPRESSCARDS

See your ExpressCard manual for specific instructions on removing your card. Some cards may require your notebook to be in Suspend Mode or Off during removal.



- Windows has a shutdown procedure for ExpressCards that must be followed before removing a card. (Review your operating system manual for the correct procedure.) It is good practice to remove devices using the Unplug or Eject Hardware icon in the system tray.
- If the dialog box states that the device cannot be removed, you must save all of your open files, close any open applications and shut down your notebook.

To remove an ExpressCard, follow these steps:

2. Unlock the card from the slot by pressing the eject button associated with the slot in which the card is located. When pressed, the button will pop out.
3. Firmly press the button again until it is flush with the notebook. This will eject the card slightly out of the slot allowing you to remove the card.

SMART CARD READER

An embedded Smart Card Reader is provided on your notebook. Smart Cards are the same size and shape as credit cards, but they contain an integrated microprocessor chip. The chip can hold a variety of different information, and provides you with many possible options, such as allowing you to make secure purchases, pay for phone calls, store security information, and provide personal identification and information.

In order to use the embedded Smart Card Reader, you must purchase an optional Smart Card adapter and third-party software for installation into an available Type II PC Card slot.

Memory Upgrade Module

Your Fujitsu LifeBook notebook comes with a minimum of 256 MB of high speed Double Data Rate Synchronous Dynamic RAM (DDR2-533 SDRAM) factory installed. To increase your notebook's memory capacity, you may install an additional memory upgrade module. The memory upgrade must be a dual-in-line (DIMM) SDRAM module. To ensure 100% compatibility, purchase the SDRAM module only from the Fujitsu web store at <http://www.computers.us.fujitsu.com>.



- Do not remove any screws from the memory upgrade module compartment except the ones specifically shown in the directions for installing and removing the memory upgrade module.
- The memory upgrade module can be severely damaged by electrostatic discharge (ESD). Be sure you are properly grounded when handling and installing the module.

INSTALLING MEMORY UPGRADE MODULES

1. Turn off power to your notebook, remove any power adapter (AC or auto/airline). Remove the battery.
2. Make sure that all the connector covers are closed.
3. Turn the notebook bottom side up, and remove the screw from the memory upgrade module compartment. (Figure 4-9)
4. Remove the cover.

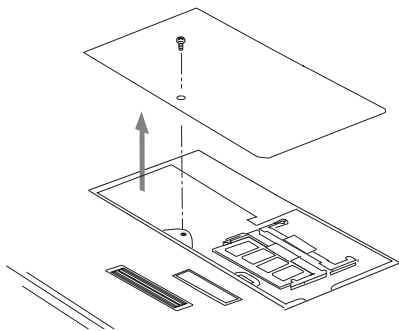

Figure 4-9. Opening the Memory Upgrade Compartment

5. Remove the memory upgrade module from the static guarded sleeve.
6. Align the memory upgrade module with the part side up. Align the connector edge of the memory upgrade module with the connector slot in the compartment.
7. Insert the memory upgrade module at a 45° angle. Press the connector edge of the module firmly down and into the connector until it lodges under the retaining clip. You will hear a click when it is properly in place. (Figure 4-10)

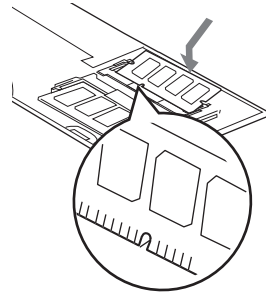

Figure 4-10. Installing a Second Memory Module

8. Replace the cover and reinstall the screw.



The memory upgrade module is not something you routinely remove from your notebook. Once it is installed, you can leave it in place unless you want to change system memory capacity.

TO REMOVE A MEMORY UPGRADE MODULE

1. Perform steps 1 through 4 of Installing a Memory Upgrade Module.
2. Pull the clips sideways away from each side of the memory upgrade module at the same time.
3. While holding the clips out, remove the module from the slot by lifting it up and pulling towards the rear of your notebook. (Figure 4-11)

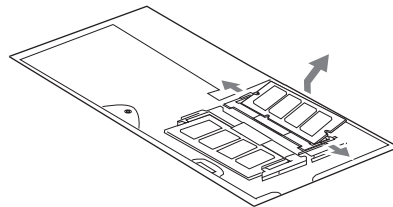

Figure 4-11. Removing a Memory Upgrade Module

4. Store the memory upgrade module in a static guarded sleeve.
5. Replace the cover and reinstall the screw.

CHECKING THE MEMORY CAPACITY

Once you have changed the system memory capacity by replacing the installed module with a larger one, be sure to check that your notebook has recognized the change.

Check the memory capacity by clicking [Start] -> Settings -> Control Panel, then double-clicking the System icon. Select the General tab and check the amount of memory under "Computer:".

There may be a variation between the actual memory size and what is displayed. This is possible if your system is configured with an integrated Intel Graphics Media Accelerator 900 which dynamically allocates system

memory to accelerate graphics performance. Up to 64 MB of memory is dynamically shared on an as-needed basis using Dynamic Video Memory Technology (DVMT).



If the total memory displayed is incorrect, check that your memory upgrade module is properly installed. (If the module is properly installed and the capacity is still not correctly recognized, see Troubleshooting on page 53.)

Device Ports

Your Fujitsu LifeBook notebook and the optional Port Replicator come equipped with multiple ports to which you can connect external devices including: disk drives, keyboards, modems, printers, etc.

MODEM (RJ-11) TELEPHONE JACK

The modem (RJ-11) telephone jack is used for an internal modem. To connect the telephone cable follow these easy steps:

1. Align the connector with the port opening.
2. Push the connector into the port until it is seated.
3. Plug the other end of the telephone cable into a telephone outlet. (Figure 4-12)

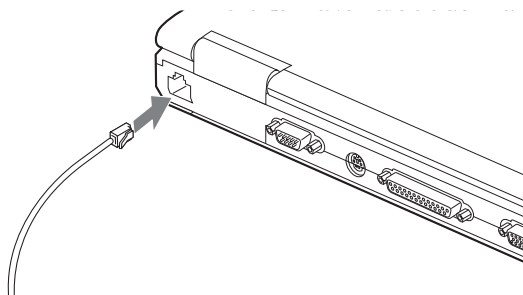

Figure 4-12. Connecting a Modem

The modem sound is deactivated by default, to activate modem sound follow these easy steps:

1. Right click on the Speaker icon in your system tray.
2. Select **Open Volume**.
3. Select **Option/Properties**.
4. Under “Show the following volume controls”, click on **Phone** and click **OK**.
5. Uncheck the Mute box under Phone Balance.



The internal modem is not intended for use with Digital PBX systems. Do not connect the internal modem to a Digital PBX as it may cause serious damage to the internal modem or your entire LifeBook notebook. Consult your PBX manufacturer's documentation for details. Some hotels have Digital PBX systems. Be sure to find out **BEFORE** you connect your modem.



- The internal modem is designed to the ITU-T V.90 standard. Its maximum speed of 53000bps is the highest allowed by FCC, and its actual connection rate depends on the line conditions. The maximum speed is 33600bps at upload.
- The internal modem on all Fujitsu LifeBook notebooks from Fujitsu are certified for use in the United States and Canada. The modem may be certified in other countries.

INTERNAL LAN (RJ-45) JACK

The internal LAN (RJ-45) jack is used for a Gigabit (10Base-T/100Base-Tx/1000Base-T) Ethernet LAN connection. You may need to configure your notebook to work with your particular network. (Please refer to your network administrator for information on your network configuration.) To connect the LAN cable follow these easy steps:

1. Align the connector with the port opening.
2. Push the connector into the port until it is seated. (Figure 4-13)
3. Plug the other end of the cable into a LAN outlet.

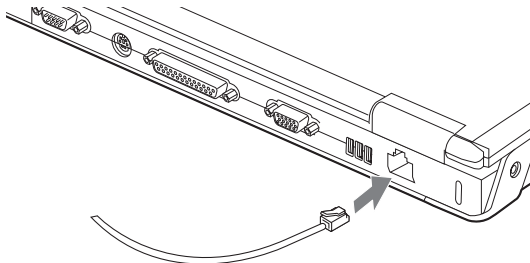

Figure 4-13. Connecting the LAN

PARALLEL PORT

The parallel port, or LPT port, located on the system and on the optional Port Replicator allows you to connect parallel devices, such as a printer to your notebook. In order to connect a parallel interface device follow these easy steps:

1. Align the connector with the port opening.
2. Push the connector into the port until it is seated. (Figure 4-14)
3. Tighten the two hold-down screws, located on each end of the connector.

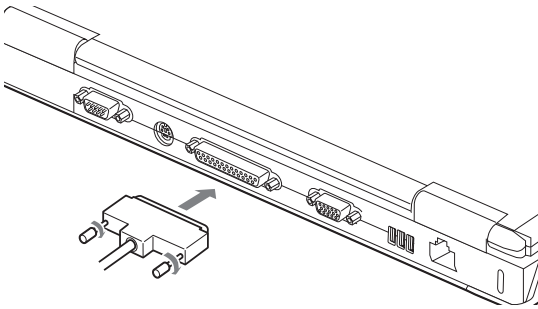

Figure 4-14. Connecting a Parallel Device

SERIAL PORT

The serial port, or COM port, located on the system and on the optional Port Replicator allows you to connect serial devices, such as printers or scanners. In order to connect a serial interface device follow these easy steps:

1. Align the connector with the port opening.
2. Push the connector into the port until it is seated.
3. Tighten the two hold-down screws, located on each end of the connector.

PS/2 PORT

The PS/2 port located on the system and on the optional Port Replicator allow you to connect an external keyboard or mouse. In order to connect a PS/2 interface device follow these easy steps:

1. Align the connector with the port opening.(Figure 4-15)
2. Push the connector into the port until it is seated.



A mouse or keyboard may be installed and automatically recognized by your notebook without restarting or changing set-ups.

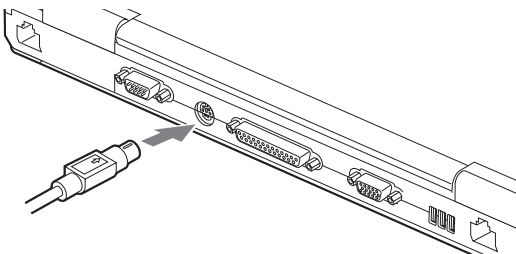

Figure 4-15. Connecting a PS/2 Device

DOCKING PORT

The docking port is used for the connection of your notebook to an optional port replicator or docking station. In order to connect your notebook to one of these devices follow the instructions that came with your docking port. (See figure 2-8 on page 11 for location)

UNIVERSAL SERIAL BUS PORTS

The Universal Serial Bus 2.0 ports (USB) allow you to connect USB devices such as external game pads, pointing devices, keyboards and/or speakers.

In order to connect a USB device follow these steps:

1. Align the connector with the port opening.(Figure 4-16)
2. Push the connector into the port until it is seated.



Due to the ongoing changes in USB technology and standards, not all USB devices and/or drivers are guaranteed to work.

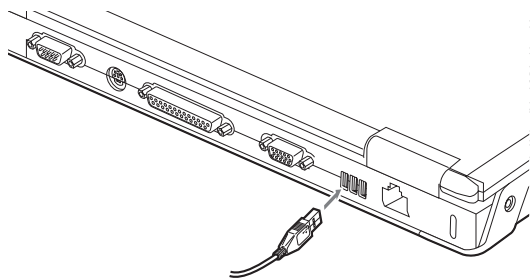

Figure 4-16. Connecting a USB Device

INFRARED PORT

The Infrared IrDA (4Mbps) port allows for wireless data transfer between your notebook and other IrDA-compatible devices, such as another computer or a printer, without the use of a cable. (See figure 2-4 on page 7 for location)

It is important to keep in mind that while carrying out this form of communication, both devices must be placed so their infrared ports are directly facing each other without obstruction. The devices must also be separated by at least 6" but no more than 36" for maximum performance.

The following conditions may interfere with infrared communications:

- A television, radio remote control unit, or a wireless headphone is being used nearby.
- Direct sunlight, fluorescent light, or incandescent light shines directly on the port.



- Do not move either device while communication is active as it may interrupt data transmission.
- Be careful not to scratch the infrared port lens. Dirt, scratches, or other surface marks can degrade operation.

IEEE 1394 PORT

The 4-pin 1394 port allows you to connect digital devices that are compliant with IEEE 1394 standard. The IEEE 1394 standard is easy to use, connect, and disconnect. This port can allow up to 400 Mbps transfer rate. A third-party application may be required to operate your digital device with the 1394 port.



The 1394 port used in this system uses a four-pin configuration. If you intend to interface with devices which use a six-pin configuration, you will need to purchase an adapter.

In order to connect a 1394 device, follow these steps:

1. Align the connector with the port opening.
2. Push the connector into the port until it is seated. (Figure 4-17)

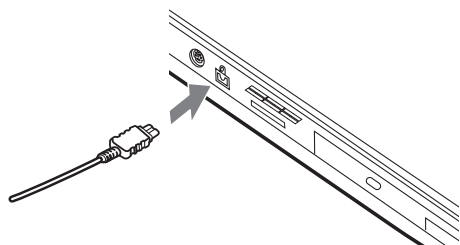

Figure 4-17. Connecting an IEEE 1394 Device

HEADPHONE JACK*

The headphone jack allows you to connect headphones or powered external speakers to your notebook. Your headphones or speakers must be equipped with a 1/8" (3.5 mm) stereo mini-plug. In order to connect headphones or speakers follow these easy steps: (See figure 2-6 on page 9 for location)

1. Align the connector with the port opening.
2. Push the connector into the port until it is seated.



If you plug headphones into the headphone jack, the built-in stereo speakers will be disabled.

MICROPHONE JACK**

The microphone jack allows you to connect an external mono microphone. Your microphone must be equipped with a 1/8" (3.5 mm) mono mini-plug in order to fit into the microphone jack of your notebook. In order to connect a microphone follow these easy steps: (See figure 2-4 on page 7 for location)

1. Align the connector with the port opening.
2. Push the connector into the port until it is seated.

EXTERNAL MONITOR PORT

The external monitor port allows you to connect an external monitor. In order to connect an external monitor follow these easy steps: (See figure 2-7 on page 10 for location)

1. Align the connector with the port opening.
2. Push the connector into the port until it is seated.
3. Tighten the two hold-down screws, located on each end of the connector.



Pressing the [Fn] + [F10] keys allows you to change your selection of where to send your display video. Each time you press the key combination, you will step to the next choice, starting with the built-in display panel only, moving to the external monitor only, finally moving to both the built-in display panel and an external monitor.

* Depending upon your system configuration, the headphone jack may serve different purposes. On some configurations, the jack serves as a stereo headphone/Optical Digital Audio Out jack. On other configurations, the jack serves as a stereo headphone/Line-Out/Optical Digital Audio Out jack.

** Depending upon your system configuration, the microphone jack may serve single or dual purposes. On configurations, the jack serves as a mono microphone jack. On other configurations, the jack serves as a stereo microphone/line-in jack.



5 Troubleshooting

Troubleshooting

There may be occasions when you encounter simple setup or operating problems that you can solve on the spot, or problems with peripheral devices that can be solved by replacing the device. The information in this section helps you isolate and resolve some of these straightforward issues and identify failures that require service.

IDENTIFYING THE PROBLEM

If you encounter a problem, go through the following procedure before pursuing complex troubleshooting:

1. Turn off your LifeBook notebook.
2. Make sure the AC adapter is plugged into your notebook and to an active AC power source.
3. Make sure that any card installed in the PC Card slot is seated properly. You can also remove the card from the slot, thus eliminating it as a possible cause of failure.
4. Make sure that any devices connected to the external connectors are plugged in properly. You can also disconnect such devices, thus eliminating them as possible causes of failure.
5. Turn on your notebook. Make sure it has been off at least 10 seconds before you turn it back on.
6. Go through the boot sequence.
7. If the problem has not been resolved, refer to the Troubleshooting Table, that follows, for more detailed troubleshooting information.



If you keep notes about what you have tried, your support representative may be able to help you more quickly by giving additional suggestions over the phone.

8. If you have tried the solutions suggested in the Troubleshooting Table without success, contact your support representative:

Toll free: 1-800-8Fujitsu (1-800-838-5487)

E-mail: 8fujitsu@us.fujitsu.com

Web site:

<http://www.computers.us.fujitsu.com/support>.

Before you place the call, you should have the following information ready so that the customer support representative can provide you with the fastest possible solution:

- Product name
- Product configuration number
- Product serial number
- Purchase date
- Conditions under which the problem occurred
- Any error messages that have occurred
- Type of device connected, if any

See the Configuration Label on the bottom of your notebook for configuration and serial numbers. (See *figure 2-8 on page 11 for location*)

SPECIFIC PROBLEMS

Using the Troubleshooting Table

When you have problems with your LifeBook notebook, try to find the symptoms under the Problem column of the troubleshooting table for the feature giving you difficulty. You will find a description of common causes for that symptom under the column Possible Cause and what, if anything, you can do to correct the condition under Possible Solutions. All possible causes or solutions may not apply to your notebook.

TROUBLESHOOTING TABLE

Problem	Page	Problem	Page
Audio Problems	page 54	Modem Problems.....	page 56
DVD/CD-ROM Drive Problems.....	page 54	Parallel, Serial and USB Device Problems.....	page 56
Port Replicator Problems.....	page 55	PC Card Problems.....	page 56
Floppy Disk Drive Problems.....	page 55	Power Failures	page 57
Hard Drive Problems.....	page 55	Shutdown and Startup Problems.....	page 58
Keyboard or Mouse Problems.....	page 55	Video Problems	page 59
Memory Problems	page 56	Miscellaneous Problems	page 61

Problem	Possible Cause	Possible Solutions
Audio Problems		
There is no sound coming from the built-in speakers.	The volume is turned too low.	Adjust the volume control on your notebook.
	The software volume control is set too low.	Adjust the sound volume control settings in your software, operating system and applications.
	Headphones are plugged into your notebook.	Plugging in headphones disables the built-in speakers, remove the headphones.
	BIOS audio settings are incorrect.	Set the BIOS setup utility to the default values within the Multimedia Device Configuration menu. (<i>See BIOS Setup Utility on page 29 for more information</i>)
	Software driver is not configured correctly.	Refer to your application and operating system documentation for help.
	The speakers have been muted using the Volume icon in the system tray.	Click on the Volume icon in the tool tray on the bottom right of the screen. (It looks like a speaker). If the Mute box is checked, click on it to uncheck it.
DVD/CD-RW/CD-ROM Drive Problems		
LifeBook notebook fails to recognize DVD/CD-RW/CD-ROM's.	Protective sheet is still in the DVD/CD-RW/CD-ROM drive tray.	Replace DVD/CD-RW/CD-ROM in tray.
	DVD/CD-RW/CD-ROM is not pushed down onto raised center circle of the drive.	Open DVD/CD-RW/CD-ROM tray and re-install DVD/CD-RW/CD-ROM properly.
	DVD/CD-RW/CD-ROM tray is not latched shut.	Push on the front of the DVD/CD-RW/CD-ROM tray until it latches.
	Incorrect DVD Player or no DVD Player software is installed.	Install DVD Player software. (<i>See "Media Player Software" on page 39 for more information.</i>)
	Wrong drive designator was used for DVD/CD-RW/CD-ROM in the application.	Verify the drive designator used by the application is the same as the one used by the operating system. When the operating system is booted from a DVD/CD, drive designations are automatically adjusted. Note that the drive designation can be changed with the Disk Management tool located at Administrative Tools -> Computer Management.
	Windows DVD/CD-RW/CD-ROM auto insertion function is disabled.	Start the DVD/CD-RW/CD-ROM from the desktop or application software or re-enable the Windows DVD/CD-RW/CD-ROM auto insertion function.

Problem	Possible Cause	Possible Solutions
LifeBook notebook fails to recognize DVD/CD-RW/CD-ROM's. (continued)	DVD/CD-RW/CD-ROM is dirty or defective.	Wipe DVD/CD-RW/CD-ROM with a non-abrasive CD cleaning cloth and reinsert. If it still will not work try another DVD/CD-RW/CD-ROM in the drive.
The DVD/CD-RW/CD-ROM Access indicator on the Status Indicator Panel blinks at regular intervals when no DVD/CD-RW/CD-ROM is in the tray or the DVD/CD-RW/CD-ROM drive is not installed.	The Windows DVD/CD-RW/CD-ROM auto insertion function is active and is checking to see if a DVD/CD-RW/CD-ROM is ready to run.	This is normal. However, you may disable this feature.
Port Replicator Problems		
Note: Be sure to power down your LifeBook notebook before adding a printer to the Port Replicator parallel port.		
LifeBook notebook does not turn on when installed in the optional Port Replicator	Port Replicator AC adapter is not plugged in.	Provide power to the Port Replicator.
	Notebook is not properly seated in the Port Replicator.	Remove and re-dock your LifeBook notebook.
Floppy Disk Drive Problems		
You cannot access your floppy disk.	You tried to write to a write protected floppy disk.	Eject the floppy disk and set it to write enable. <i>(See Preparing a Disk for Use on page 42 for more information)</i>
	Floppy disk is not loaded correctly.	Eject floppy disk, check orientation and re-insert. <i>(See Ejecting a Disk on page 42 for more information)</i>
	The floppy disk drive may not be properly installed.	Remove and re-install your floppy disk drive.
	Security is set to protect access to floppy disk data.	Verify your password and security settings.
Hard Drive Problems		
You cannot access your hard drive.	The wrong drive designator was used by an application when a bootable CD-ROM was used to start the notebook.	Verify drive designator used by application is in use by the operating system. When the operating system is booted from a CD, drive designations are automatically adjusted.
	Security is set so your operating system cannot be started without a password.	Verify your password and security settings.
Keyboard or Mouse Problems		
The built-in keyboard does not seem to work.	The notebook has gone into Suspend mode.	Push the Power/Suspend/Resume button.
	Your application has locked out your keyboard.	Try to use your integrated pointing device to restart your system.
You have installed an external keyboard or mouse, and it does not seem to work.	Your external device is not properly installed.	Re-install your device. <i>(See Device Ports on page 48 for more information)</i>

Problem	Possible Cause	Possible Solutions
You have installed an external keyboard or mouse, and it does not seem to work. (continued)	Your operating system software is not set up with correct software driver for that device.	Check your device and operating system documentation and activate the proper driver.
	Your mouse or keyboard is connected to the wrong PS/2 port on the optional Port Replicator.	Plug the mouse into the PS/2 Mouse port and the external keyboard into the PS/2 Keyboard port. (See <i>PS/2 Port on page 49</i> for more information)
You have connected an external keyboard or a mouse and it seems to be locking up the system.	Your operating system software is not set up with correct software driver for that device.	Check your device and operating system documentation and activate the proper driver.
	Your system has crashed.	Try to restart your notebook. I
Memory Problems		
Your Power On screen, or Main menu of the BIOS setup utility information, does not show the correct amount of installed memory.	Your memory upgrade module is not properly installed.	Remove and re-install your memory upgrade module. (See <i>Memory Upgrade Module on page 46</i> for more information)
	You have a memory failure.	Check for Power On Self Test (POST) messages. (See <i>Power On Self Test Messages on page 62</i> for more information)
Modem Problems		
Messages about modem operation.	Messages about modem operation are generated by whichever modem application is in use.	See your application software documentation for additional information.
Parallel, Serial, and USB Device Problems		
You have installed a parallel port device, a serial port device or a USB device. Your LifeBook notebook does not recognize the device, or the device does not seem to work properly.	The device is not properly installed.	Remove and re-install the device. (See <i>Device Ports on page 48</i> for more information)
	The device may have been installed while an application was running, so your notebook is not aware of its installation.	Close the application and restart your notebook.
	Your device may not have the correct software driver active.	See your software documentation and activate the correct driver.
	You may have the wrong I/O address selected for your device.	See your device documentation and software documentation to determine the required I/O address. Change the settings in the BIOS setup utility. (See <i>BIOS Setup Utility on page 29</i> for more information)
	Your device and another device are assigned the same I/O address.	Check all I/O addresses located within the BIOS setup utility and any other installed hardware or software to make sure there are no duplications.
	Parallel port is set to output only.	Check parallel port setting in the BIOS and set to bi-directional or ECP.
PC Card Problems		
A card inserted in the PC Card slot does not work or is locking up the system.	The card is not properly installed.	Remove and re-install the card. (See <i>PC Cards/ExpressCards™ on page 44</i> for more information)

Problem	Possible Cause	Possible Solutions
A card inserted in the PC Card slot does not work or is locking up the system. (continued)	The card may have been installed while an application was running, so your notebook is not aware of its installation.	Close the application and restart your notebook.
	Your software may not have the correct software driver active.	See your software documentation and activate the correct driver.
	You may have the wrong I/O address selected for your PC Card device.	See your PC Card documentation to determine the required I/O address. Change the settings in the BIOS. <i>(See BIOS Setup Utility on page 29 for more information)</i>
	Your PC Card device and another device are assigned the same I/O address.	Check all I/O addresses located within the BIOS setup utility and any other installed hardware or software to make sure there are no duplications.
Power Failures		
You turn on your LifeBook notebook and nothing seems to happen.	The installed primary battery is completely discharged, there is no optional second battery installed or there is no Power adapter (AC or Auto/Airline) installed.	Check the Status Indicator Panel to determine the presence and condition of the batteries. <i>(See Status Indicator Panel on page 12 for more information)</i> Install a charged battery or a Power adapter.
	The primary battery is installed but is faulty.	Use the Status Indicator panel to verify the presence and condition of the batteries. <i>(See Status Indicator Panel on page 12 for more information)</i> If a battery is indicating a short, remove that battery and operate from another power source or replace that battery.
	The battery or batteries are low.	Check the Status Indicator Panel to determine the presence and condition of the batteries. <i>(See Status Indicator Panel on page 12 for more information)</i> Use a Power adapter to operate until a battery is charged or install a charged battery.
	The power adapter (AC or auto/airline) is not plugged in properly.	Verify that your adapter is connected correctly. <i>(See Power Sources on page 27 for more information)</i>
	The Power adapter (AC or auto/airline) has no power from the AC outlet, airplane seat jack, or the car's cigarette lighter.	Move the AC cord to a different outlet, check for a line switch or tripped circuit breaker for the AC outlet. If you are using an auto/airline adapter in a car make sure the ignition switch is in the On or Accessories position.
	The Power adapter (AC or auto/airline) is faulty.	Try a different Power adapter or install a charged optional second battery.
Your LifeBook notebook turns off all by itself.	The power management parameters are set for auto timeouts which are too short for your operating needs.	Press any button on the keyboard, or move the mouse to restore operation. If that fails, push the Power/Suspend/Resume button. Check your power management settings, or close your applications and go to the Power Savings menu of the setup utility to adjust the timeout values to better suit your needs.

Problem	Possible Cause	Possible Solutions
Your LifeBook notebook turns off all by itself. (continued)	You are operating on battery power only and have ignored a low battery alarm until the batteries are all at the dead battery state and your machine has gone into Dead Battery Suspend mode.	Install a power adapter and then push the Power/Suspend/Resume button. (See <i>Power Sources on page 27 for more information</i>)
	You have a battery failure.	Verify the condition of the batteries using the Status Indicator panel, and replace or remove any batteries that are shorted. (See <i>Status Indicator Panel on page 12 for more information</i>)
	Your power adapter has failed or lost its power source.	Make sure the adapter is plugged in and the outlet has power.
Your LifeBook notebook will not work on battery alone.	The installed batteries are dead.	Replace the battery with a charged one or install a Power adapter.
	No batteries are installed.	Install a charged battery.
	The batteries are improperly installed.	Verify that the batteries are properly connected by re-installing them.
	Your installed batteries are faulty.	Verify the condition of the batteries using the Status Indicator panel and replace or remove any batteries that are shorted. (See <i>Status Indicator Panel on page 12 for more information</i>)
The batteries seem to discharge too quickly.	You are running an application that uses a lot of power due to frequent hard drive access or DVD/CD-ROM access, use of a modem or LAN PC card.	Use both the primary battery and an optional second battery and/or use a power adapter for this application when at all possible.
	The power savings features may be disabled.	Check the power management and/or setup utility settings in the Power Savings menu and adjust according to your operating needs.
	The brightness is turned all the way up.	Turn down the brightness adjustment. The higher the brightness the more power your display uses.
	The batteries are very old.	Replace the batteries.
	The batteries have been exposed to high temperatures.	Replace the batteries.
	The batteries are too hot or too cold.	Restore the notebook to normal operating temperature. Charging icon on the Status Indicator panel will flash when battery is outside of operating range.
Shutdown and Startup Problems		
The Suspend/Resume button does not work.	Suspend/Resume button is disabled from the Power -> Advanced submenu of the setup utility.	Enable the button from the setup utility.
	You did not hold the button in long enough.	Hold the button longer. This may need to be a few seconds if your application is preventing the CPU from checking for button pushes.

Problem	Possible Cause	Possible Solutions
The Suspend/Resume button does not work. (continued)	There may be a conflict with the application software.	Close all applications and try the button again.
The system powers up, and displays power on information, but fails to load the operating system.	The boot sequence settings of the setup utility are not compatible with your configuration.	Set the operating source by pressing the [ESC] key while the Fujitsu logo is on screen or use the [F2] key and enter the setup utility and adjust the source settings from the Boot menu. (<i>See BIOS Setup Utility on page 29 for more information</i>)
	You have a secured system requiring a password to load your operating system.	Make sure you have the right password. Enter the setup utility and verify the Security settings and modify them as accordingly. (<i>See BIOS Setup Utility on page 29 for more information</i>)
	Internal hard drive was not detected.	Use the BIOS setup utility or Primary Master submenu, located within the Main menu, to try to auto detect the internal hard drive.
An error message is displayed on the screen during the notebook (boot) sequence.	Power On Self Test (POST) has detected a problem.	See the Power On Self Test (POST) messages to determine the meaning and severity of the problem. Not all messages are errors; some are simply status indicators. (<i>See Power On Self Test Messages on page 62 for more information</i>)
Your notebook appears to change setup parameters when you start it.	BIOS setup changes were not saved when you made them and exited the setup utility returning it to earlier settings.	Make sure you select Save Changes And Exit when exiting the BIOS setup utility.
	The BIOS CMOS hold-up battery has failed.	Contact your support representative for repairs. This is not a user serviceable part but has a normal life of 3 to 5 years.
Your system display won't turn on when the system is turned on or when the system has resumed.	The system may be password-protected.	Check the status indicator panel to verify that the Security icon is blinking. If it is blinking, enter your password.
Video Problems		
The built-in display is blank when you turn on your LifeBook notebook.	Something is pushing on the Closed Cover switch.	Clear the Closed Cover switch. (<i>See figure 2-3 on page 6 for location</i>)
	The notebook is set for an external monitor only.	Pressing [F10] while holding down the [Fn] key allows you to change your selection of where to send your display video. Each time you press the keys you will step to the next choice. The choices, in order are: built-in display only, external monitor only, both built-in display and external monitor.
	The display angle and brightness settings are not adequate for your lighting conditions.	Move the display and the brightness control until you have adequate visibility.
	The power management time-outs may be set for very short intervals and you failed to notice the display come on and go off again.	Press any button the keyboard, or move the mouse to restore operation. If that fails, push the Power/Suspend/Resume button. (The display may be shut off by Standby mode, Auto Suspend or Video Timeout)

Problem	Possible Cause	Possible Solutions
The LifeBook notebook turned on with a series of beeps and your built-in display is blank.	Power On Self Test (POST) has detected a failure which does not allow the display to operate.	Contact your support representative.
The display goes blank by itself after you have been using it.	The notebook has gone into Video timeout, Standby mode, Suspend mode or Save-to-Disk mode because you have not used it for a period of time.	Press any button on the keyboard, or move the mouse to restore operation. If that fails, push the Power/Suspend/Resume button. Check your power management settings, or close your applications and go to the Power Savings menu of the setup utility to adjust the timeout values to better suit your operation needs. (See <i>BIOS Setup Utility</i> on page 29 for more information)
	The power management timeouts may be set for very short intervals and you failed to notice the display come on and go off again.	Press any button on the keyboard, or move the mouse to restore operation. If that fails, push the Power/Suspend/Resume button. (The display may be shut off by Standby Mode, Auto Suspend or Video Timeout)
	Something is pushing on the Closed Cover switch.	Check the Closed Cover switch. (See figure 2-3 on page 6 for location)
Your system display won't turn on when the system is turned on or when the system has resumed.	The system may be password-protected.	Check the status indicator panel to verify that the Security icon is blinking. If it is blinking, enter your password.
The Built-in Display does not close.	A foreign object, such as a paper clip, is stuck between the display and the keyboard.	Remove all foreign objects from the keyboard.
The Built-in Display has bright or dark spots.	If the spots are very tiny and few in number, this is normal for a large LCD display.	This is normal; do nothing.
	If the spots are numerous or large enough to interfere with your operation needs.	Display is faulty; contact your support representative.
The application display uses only a portion of your screen and is surrounded by a dark frame.	You are running an application that does not support 800 x 600/1024 x 768 pixel resolution display and display compression is enabled.	Display compression gives a clearer but smaller display for applications that do not support 800 x 600/1024 x 768 pixel resolution. You can fill the screen but have less resolution by changing your display compression setting, (See the Video Features submenu, located within the Advanced menu of the BIOS. (See <i>BIOS Setup Utility</i> on page 29 for more information)
The Display is dark when on battery power.	The Power Management utility default is set on low brightness to conserve power.	Press [Fn] + [F7] to increase brightness or double-click on the battery gauge and adjust Power Control under battery settings.
You have connected an external monitor and it does not display any information.	Your BIOS setup is not set to enable your external monitor.	Toggle the video destination by pressing [Fn] + [F10] together, or check your BIOS setup and enable your external monitor. (See the Video Features submenu, located within the Advanced Menu of the BIOS. (See <i>BIOS Setup Utility</i> on page 29 for more information)

Problem	Possible Cause	Possible Solutions
You have connected an external monitor and it does not display any information. (continued)	Your external monitor is not properly installed.	Reinstall your device. <i>(See External Monitor Port on page 50 for more information)</i>
	Your operating system software is not setup with the correct software driver for that device.	Check your device and operating system documentation and activate the proper driver.
You have connected an external monitor and it does not come on.	Your external monitor is not compatible with your LifeBook notebook.	See your monitor documentation and the External Monitor Support portions of the Specifications section. <i>(See Specifications on page 75 for more information)</i>
Miscellaneous Problems		
An error message is displayed on the screen during the operation of an application.	Application software often has its own set of error message displays.	See your application manual and help displays screens for more information. Not all messages are errors some may simply be status.

POWER ON SELF TEST MESSAGES

The following is an alphabetic list of error-and-status messages that Phoenix BIOS and/or your operating system can generate and an explanation of each message. Error messages are marked with an *. If an error message is displayed that is not in this list, write it down and check your operating system documentation both on screen and in the manual. If you can find no reference to the message and its meaning is not clear, contact your support representative for assistance.

nnnn Cache SRAM Passed

Where nnnn is the amount of system cache in kilobytes successfully tested by the Power On Self Test. (This can only appear if you have an SRAM PC Card installed.)

***Diskette drive A error or Diskette drive B error**

Drive A: or B: is present but fails the BIOS Power On Self Test diskette tests. Check to see that the drive is defined with the proper diskette type in the Setup Utility, (*See BIOS Setup Utility on page 29 for more information*) and that the diskette drive is installed correctly. If the disk drive is properly defined and installed, avoid using it and contact your support representative.

***Extended RAM Failed at offset: nnnn**

Extended memory not working or not configured properly. If you have an installed memory upgrade module, verify that the module is properly installed. If it is properly installed, you may want to check your Windows Setup to be sure it is not using unavailable memory until you can contact your support representative.

nnnn Extended RAM Passed

Where nnnn is the amount of memory in kilobytes successfully tested.

***Failing Bits: nnnn The hex number nnnn**

This is a map of the bits at the memory address (in System, Extended, or Shadow memory) which failed the memory test. Each 1 (one) in the map indicates a failed bit. This is a serious fault that may cause you to lose data if you continue. Contact your support representative.

***Fixed Disk x Failure or Fixed Disk Controller Failure (where x = 1-4)**

The fixed disk is not working or not configured properly. This may mean that the hard drive type identified in your setup utility does not agree with the type detected by the Power On Self Test. Run the setup utility to check for the hard drive type settings and correct them if necessary. If the settings are OK and the message appears when you restart the system, there may be a serious fault which might cause you to lose data if you continue. Contact your support representative.

***Incorrect Drive A type – run SETUP**

Type of floppy drive A: not correctly identified in Setup. This means that the floppy disk drive type identified in your setup utility does not agree with the type detected by the Power On Self Test. Run the setup utility to correct the inconsistency.

***Incorrect Drive B type – run SETUP**

Type of floppy drive B: not correctly identified in Setup. This means that the floppy disk drive type identified in your setup utility does not agree with the type detected by the Power On Self Test. Run the setup utility to correct the inconsistency.

***Invalid NVRAM media type**

Problem with NVRAM access. In the unlikely case that you see this message you may have some display problems. You can continue operating but should contact your support representative for more information.

***Keyboard controller error**

The keyboard controller test failed. You may have to replace your keyboard or keyboard controller but may be able to use an external keyboard until then. Contact your support representative.

***Keyboard error**

Keyboard not working. You may have to replace your keyboard or keyboard controller but may be able to use an external keyboard until then. Contact your support representative.

***Keyboard error nn**

BIOS discovered a stuck key and displays the scan code for the stuck key. You may have to replace your keyboard but may be able to use an external keyboard until then. Contact your support representative.

***Monitor type does not match CMOS – Run SETUP**

Monitor type not correctly identified in Setup. This error probably means your BIOS is corrupted, run the setup utility and set all settings to the default conditions. If you still get this error, contact your support representative.

***Operating system not found**

Operating system cannot be located on either drive A: or drive C: Enter the setup utility and see if both the fixed disk, and drive A: are properly identified and that the boot sequence is set correctly. Unless you have changed your installation greatly, the operating system should be on drive C:. If the setup utility is correctly set, your hard drive may be corrupted.

***Parity Check 1 nnnn**

Parity error found in the system bus. BIOS attempts to locate the address and display it on the screen. If it cannot locate the address, it displays ????. This is a potentially data destroying failure. Contact your support representative.

***Parity Check 2 nnnn**

Parity error found in the I/O bus. BIOS attempts to locate the address and display it on the screen. If it cannot locate the address, it displays ?????. This is a potentially data-destroying failure. Contact your support representative.

***Press <F1> to resume, <F2> to SETUP**

Displayed after any recoverable error message. Press the [F1] key to continue the boot process or the [F2] key to enter Setup and change any settings.

***Previous boot incomplete – Default configuration used**

Previous Power On Self Test did not complete successfully. The Power On Self Test will load default values and offer to run Setup. If the previous failure was caused by incorrect values and they are not corrected, the next boot will likely fail also. If using the default settings does not allow you to complete a successful boot sequence, you should turn off the power and contact your support representative.

***Real time clock error**

Real-time clock fails BIOS test. May require board repair. Contact your support representative.

***Shadow RAM Failed at offset: nnnn**

Shadow RAM failed at offset nnnn of the 64k block at which the error was detected. You are risking data corruption if you continue. Contact your support representative.

nnnn Shadow RAM Passed

Where nnnn is the amount of shadow RAM in kilobytes successfully tested.

***System battery is dead – Replace and run SETUP**

The BIOS CMOS RAM memory hold up battery is dead. This is part of your BIOS and is a board mounted battery which requires a support representative to change. You can continue operating but you will have to use setup utility default values or reconfigure your setup utility every time you turn off your notebook. This battery has an expected life of 2 to 3 years.

System BIOS shadowed

System BIOS copied to shadow RAM.

***System CMOS checksum bad – run SETUP**

BIOS CMOS RAM has been corrupted or modified incorrectly, perhaps by an application program that changes data stored in BIOS memory. Run Setup and reconfigure the system.

***System RAM Failed at offset: nnnn**

System memory failed at offset nnnn of in the 64k block at which the error was detected. This means that there is a fault in your built-in memory. If you continue to operate, you risk corrupting your data. Contact your support representative for repairs.

nnnn System RAM Passed

Where nnnn is the amount of system memory in kilobytes successfully tested.

***System timer error**

The timer test failed. The main clock that operates the computer is faulty. Requires repair of system board. Contact your support representative for repairs.

UMB upper limit segment address: nnnn

Displays the address of the upper limit of Upper Memory Blocks, indicating released segments of the BIOS memory which may be reclaimed by a virtual memory manager.

Video BIOS shadowed

Video BIOS successfully copied to shadow RAM.

**EMERGENCY MEDIA PLAYER
DRIVE TRAY RELEASE**

If for some reason the eject button fails, you can open the DVD/CD-ROM tray with a paper clip or similar tool inserted into the eject hole in the far right side of the front of the tray. Straighten one side of a paper clip and push it gently into the hole. The tray will pop out a short distance.

MODEM RESULT CODES

The operating system and application software that is factory installed detects the modem characteristics and provides the necessary command strings to operate the modem. The internal modem operation is controlled by generic AT commands from the operating system and application software. The standard long form result codes may, in some cases, be displayed on your screen to keep you informed of the actions of your modem. The operating system and application software may suppress display of the result codes.

Examples of result codes are:

- OK
- NO CARRIER
- NO DIALTONE
- CONNECT 53000 (Connection complete at 53,000 bps.)
- ERROR
- FAX
- RING (This means an incoming call.)
- BUSY
- NO ANSWER

When using the internal modem with applications that are not factory installed refer to the application documentation.

RESTORING YOUR PRE-INSTALLED SOFTWARE

The Drivers and Applications Restore (DAR) DVD contains sets of device drivers and Fujitsu utilities (in specific directories) that are unique to your computer configuration for use as documented below.



In order to install applications and/or drivers from the DAR DVD, you will need to use a DVD drive either in your system or attached externally.



If you have access to the internet, visit the Fujitsu Support web site at <http://www.computers.us.fujitsu.com/support> to check for the most current information, drivers and hints on how to perform recovery and system updates.

Re-Installing Individual Drivers and Applications

The Drivers and Applications CD can be used to selectively re-install drivers and/or applications that may have been un-installed or corrupted.



There may be certain free third-party applications pre-installed on your system that are not on the DAR CD. The latest versions of the applications can be downloaded from the third-party's website.

To re-install drivers and/or applications:

1. Boot up the system and insert the DAR CD after Windows has started. A Fujitsu Installer screen is displayed after the CD is inserted.
2. After reading the License Agreement, click [I agree].
3. A window will appear containing a list of applications, drivers, and utilities that you can install from the Drivers and Applications CD.



The components listed are color-coded in terms of their install status. Blue indicates that the component can be installed. Green indicates that the component needs to be installed separately. Grey indicates a component that is already installed; grey items can be reinstalled, but prior to installation you will receive a reminder that the component is already installed.

4. In the list, check off all the components you want to install. If you want to install all components, click [Select All]. Clicking [Select All] will select all of the blue-coded components; you must select grey and green components separately.

5. Once you have selected the components you wish to install, click [Install Selected Subsystems]; the components will be installed.
6. After the components are installed, click [OK], then click [Yes] when asked if you want to reboot the system.

RESTORING THE FACTORY IMAGE

The Restore Disc that came with your system contains two utilities:

- The **Recovery** utility allows you to restore the original contents of the C: drive.
- The **Hard Disk Data Delete** utility on this disc is used to delete all data on your hard disk and prevent it from being reused. Do not use the Hard Disk Data Delete utility unless you are absolutely certain that you want to erase your entire hard disk, including all partitions.



- The use of this disc requires that you have a device capable of reading DVDs attached to your system. If you do not have a built-in DVD player, you will need to attach an external player. For more information on available external devices, visit our Web site at: us.fujitsu.com/computers.

- This disc can only be used with the system with which it was purchased.

BOOT Priority Change

Before restoring an image, you must first verify that your system is set up to boot from the DVD drive. To verify/change the boot-up priority (rather than booting-up from the hard drive or an external floppy disk drive), perform the following steps:

1. Start your system and press the [F2] key when the Fujitsu logo appears. You will enter the BIOS Setup Utility.
2. Using the arrow keys, go to the Boot menu.
3. Arrow down to the Boot Device Priority submenu. Press [Enter].
4. If "Optical Media Drive" or "CD-ROM Drive" is not at the top of the list, arrow down to the drive in the list, and press the space bar (or the + key) to move it to the top of the list. (The system attempts to boot from the devices in the order in which they are listed.) Note that the BIOS for some systems will indicate "CD-ROM Drive", even when a DVD drive is connected.
5. If you have an *external* DVD drive connected, proceed to the next step; otherwise, proceed to step 7.

6. If you have an external DVD drive connected:
 - Select the Advanced menu in the BIOS window.
 - Scroll down to the USB Features submenu and press the Enter key to open it.
 - If Legacy USB Support is disabled, press the space bar to enable it.
 - Scroll down to SCSI SubClass Support and press the space bar to enable it.
7. Press [F10], then click on [Yes] to exit the BIOS Setup Utility and return to the boot process.

After you have changed the boot priority, you can restore a backup image when you are booting up.

Procedure

1. Turn on the power to your system.
2. Ensure that you have a device that can read DVDs either installed in your system or attached externally to it.
3. Insert the Restore Disc into the drive tray.
4. Reboot your system.
5. After the system reboots, follow the instructions that appear to either restore your system image or erase all data from your hard disk.

AUTOMATICALLY DOWNLOADING DRIVER UPDATES

Your system has a convenient tool called the Fujitsu Driver Update (FDU) utility. With FDU, you can choose to automatically or manually go to the Fujitsu site to check for new updates for your system.

The FDU icon should appear in the system tray at the bottom right of your screen (roll the cursor over the icons to find the correct one). If the FDU icon does not appear in the system tray, it can be started by going to [Start] -> All Programs, and clicking on Fujitsu Driver Update; this will create the icon automatically.

To invoke the FDU menu, you can either right-click on the FDU icon or hold the pen on the icon for a couple of seconds until the menu appears. The menu contains the following items:

- **Check for updates now**
Allows for manual driver update search. The first time it is used, you are prompted to agree to a user agreement. After clicking on the icon, the FDU automatically connects with the Fujitsu site to check for updates and downloads them. While downloading, the icon has a red bar through it, indicating that it cannot be used while the download is in process. When the update is complete, a message appears informing you of the fact.
- **Enable Automatic Update Notifications**
Automatically searches for new updates on a regular basis (approximately every 3 days).
- **Show update history**
Brings up a screen that displays a history of updates that have been made via the FDU.
- **About Fujitsu Driver Update**
Displays the FDU version number and copyright information
- **Fujitsu Driver Update Readme**
Displays the FDU readme.



6 **Care and Maintenance**

Care and Maintenance

If you use your Fujitsu LifeBook notebook carefully, you will increase its life and reliability. This section provides some tips for looking after the notebook and its devices.



Electrical equipment may be hazardous if misused. Operations of this product or similar products, must always be supervised by an adult. Do not allow children access to the interior of any electrical products and do not permit them to handle any cables.

Caring for your LifeBook notebook

- Your LifeBook notebook is a durable but sensitive electronic device. Treat it with respect and care.
- Make a habit of transporting it in a suitable carrying case.
- Do not attempt to service the computer yourself. Always follow installation instructions closely.
- Keep it away from food and beverages.
- If you accidentally spill liquid on your LifeBook notebook:
 1. Turn it off.
 2. Position it so that the liquid can run out.
 3. Let it dry out for 24 hours, or longer if needed.
 4. If your notebook will not boot after it has dried out, call your support representative.
- Do not use your Fujitsu LifeBook notebook in a wet environment (near a bathtub, swimming pool).
- Always use the AC adapter and batteries that are approved for your notebook.
- Avoid exposure to sand, dust and other environmental hazards.
- Do not expose your notebook to direct sunlight for long periods of time as temperatures above 140° F (60° C) may damage your notebook.
- Keep the covers closed on the connectors and slots when they are not in use.
- Do not put heavy or sharp objects on the computer.
- If you are carrying your LifeBook notebook in a briefcase, or any other carrying case, make sure that there are no objects in the case pressing on the lid.
- Never position your notebook such that the optical drive is supporting the weight of the notebook.
- Do not drop your notebook.
- Do not touch the screen with any sharp objects.

Cleaning your LifeBook notebook





- Always disconnect the power plug. (Pull the plug, not the cord.)
- Clean your LifeBook notebook with a damp, lint-free cloth. Do not use abrasives or solvents.
- Use a soft cloth to remove dust from the screen. Never use glass cleaners.

Storing your LifeBook notebook

- If storing your notebook for a month or longer, turn your LifeBook notebook off, fully charge the battery(s), then remove and store all Lithium ion batteries.
- Store your notebook and batteries separately. If you store your LifeBook with a battery installed, the battery will discharge, and battery life will be reduced. In addition, a faulty battery might damage your LifeBook.
- Store your Fujitsu LifeBook in a cool, dry location. Temperatures should remain between 13°F (-25°C) and 140°F (60°C).

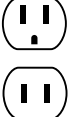
Traveling with your LifeBook notebook

- Do not transport your notebook while it is turned on.
- It is recommended that you carry your notebook with you while travelling, rather than checking it in as baggage.
- Always bring your System Recovery CD that came with your notebook when you travel. If you experience system software problems while traveling, you may need it to correct any problems.
- Never put your notebook through a metal detector. Have your notebook hand-inspected by security personnel. You can however, put your notebook through a properly tuned X-ray machine. To avoid problems, place your notebook close to the entrance of the machine and remove it as soon as possible or have your notebook hand-inspected by security personnel. Security officials may require you to turn your notebook On. Make sure you have a charged battery on hand.
- When traveling with the hard drive removed, wrap the drive in a non-conducting materials (cloth or paper). If you have the drive checked by hand, be ready to install the drive if needed. Never put your hard drive through a metal detector. Have your hard drive hand-inspected by security personnel. You can however, put your hard drive through a properly tuned X-ray machine.
- Take the necessary plug adapters if you're traveling overseas. Check the following diagram to determine which plug adapter you'll need or ask your travel agent.

Outlet Type	Location
	United States, Canada, parts of Latin America, Mexico, Japan, Korea, the Philippines, Taiwan
	Russia and the Commonwealth of Independent States (CIS), most of Europe, parts of Latin America, the Middle East, parts of Africa, Hong Kong, India, most of South Asia
	United Kingdom, Ireland, Malaysia, Singapore, parts of Africa
	China, Australia, New Zealand

BATTERIES

Caring for your Batteries

- Always handle batteries carefully.
- Do not short-circuit the battery terminals (that is, do not touch both terminals with a metal object). Do not carry loose batteries in a pocket or purse where they may mix with coins, keys, or other metal objects. Doing so may cause an explosion or fire.
- Do not drop, puncture, disassemble, mutilate or incinerate the battery.
- Recharge batteries only as described in this manual and only in ventilated areas.
- Do not leave batteries in hot locations for more than a day or two. Intense heat can shorten battery life.
- Do not leave a battery in storage for longer than 6 months without recharging it.

Increasing Battery Life

- Power your LifeBook notebook through the AC or optional auto/airline adapter whenever possible.
- If your notebook is running on battery power all day, connect it to the AC adapter overnight to recharge the battery.
- Keep brightness to the lowest level comfortable.
- Set the power management for maximum battery life.
- Put your notebook in Suspend mode when it is turned on and you are not actually using it.
- Limit your media drive access.

- Disable the Media Player auto insert notification function.
- Always use fully charged batteries.
- Eject PCMCIA™ cards when not in use.

FLOPPY DISKS AND DRIVES

Caring for your Floppy Disks

- Avoid using the floppy disks in damp and dusty locations.
- Never store a floppy disk near a magnet or magnetic field.
- Do not use a pencil or an eraser on a disk or disk label.
- Avoid storing the floppy disks in extremely hot or cold locations, or in locations subject to severe temperature changes. Store at temperatures between 50° F (10°C) and 125° F (52°C).
- Do not touch the exposed part of the disk behind the metal shutter.
- Never use the floppy disk drive with any liquid, metal, or other foreign matter inside the floppy disk drive or disk.
- Never disassemble your floppy disk drive.

MEDIA CARE

Caring for your Media (DVD/CD/CD-R)

Media discs are precision devices and will function reliably if given reasonable care.

- Always store your media disc in its case when it is not in use.
- Always handle discs by the edges and avoid touching the surface.
- Avoid storing any media discs in extreme temperatures.
- Do not bend media discs or set heavy objects on them.
- Do not spill liquids on media discs.
- Do not scratch media discs.
- Do not get dust on media discs.
- Never write on the label surface with a ballpoint pen or pencil. Always use a felt pen.
- If a media disc is subjected to a sudden change in temperature, cold to warm condensation may form on the surface. Wipe the moisture off with a clean, soft, lint free cloth and let it dry at room temperature. DO NOT use a hair dryer or heater to dry media discs.
- If a disc is dirty, use only a DVD/CD cleaner or wipe it with a clean, soft, lint free cloth starting from the inner edge and wiping to the outer edge.

Caring for your Optical Drive

Your optical drive is durable but you must treat it with care. Please pay attention to the following points:

- The drive rotates the compact disc at a very high speed. Do not carry it around or subject it to shock or vibration with the power on.
- Avoid using or storing the drive where it will be exposed to extreme temperatures.
- Avoid using or storing the drive where it is damp or dusty.
- Avoid using or storing the drive near magnets or devices that generate strong magnetic fields.
- Avoid using or storing the drive where it will be subjected to shock or vibration.
- Do not disassemble or dismantle the optical drive.
- Use of a commercially available lens cleaner is recommended for regular maintenance of your drive.

PC CARDS/EXPRESSCARDS

Caring for your Cards

PC Cards and ExpressCards are durable, but you must treat them with care. The documentation supplied with your card will provide specific information, but you should pay attention to the following points:

- To keep out dust and dirt, store cards in their protective sleeves when they are not installed in your LifeBook notebook.
- Avoid prolonged exposure to direct sunlight or excessive heat.
- Keep the cards dry.
- Do not flex or bend the cards, and do not place heavy objects on top of them.
- Do not force cards into the slot.
- Avoid dropping cards, or subjecting them to excessive vibration.



7 Specifications

Specifications

This section provides the hardware and environmental specifications for your Fujitsu LifeBook notebook. Specifications of particular configurations will vary.

CONFIGURATION LABEL

There is a configuration label located on the bottom of your LifeBook notebook. (See Figure 2-8 on page 11 for location). This label contains specific information regarding the options you've chosen for your notebook. Following is an example label and information on how to read your own configuration label.

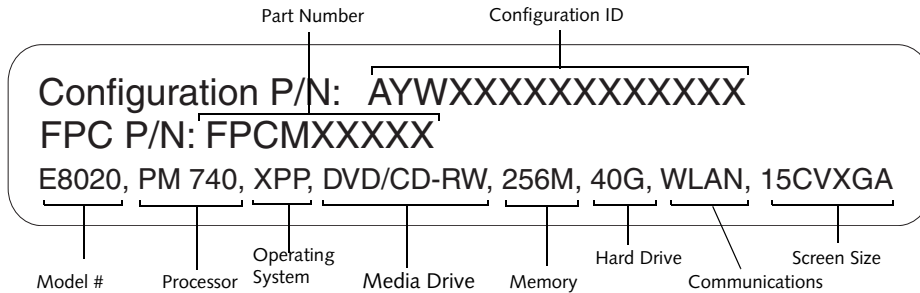

Figure 7-1 Configuration Label

MICROPROCESSOR

Intel Pentium M processor (Refer to the system label to determine the speed of your processor).

CHIPSET

- Intel 915 GM/PM
- I/O Controller Hub 6 Mobile (ICH-M)

MEMORY

System Memory

- DDR2-533 MHz SDRAM dual-channel memory module.
- Two DIMM slots; upgradeable to 2 GB of total memory (1 GB x 2)

Cache Memory

2 MB L2 cache on-die

VIDEO

Built-in color flat-panel TFT active matrix LCD display with simultaneous display capability

Video Color and Resolution

15" Crystal View XGA model:

- Internal: 1024 x 768 pixel resolution, 16M colors
- External: 1600 x 1200 pixel resolution, 16M colors
- Simultaneous Video: 1024 x 768, 16M colors. XGA, SVGA and VGA compatible

15" TFT SXGA+ model:

- Internal: 1400 x 1050 pixel resolution, 16M colors
- External: 1600 x 1200 pixel resolution, 16M colors
- Simultaneous Video: 1400 x 1050 pixel resolution, 16M colors

Video RAM

Depending upon your system configuration, one of the following is installed in your system.

- Intel® Graphics Media Accelerator 900 video graphics. Up to 128 MB shared video memory using Dynamic Video Memory Technology (DVMT), or,
- ATI® MOBILITY™ RADEON™ X600 (PCI Express interface) with dedicated 64 MB of video memory for smooth graphics, brilliant video, and cinematic picture quality.

AUDIO

- Azalia codec ALC260 or AC'97 codec ALC203, depending upon system configuration.

Headphones

Depending upon your system configuration, you have one of the following:

- Stereo headphone/SPDIF jack, 3.5 mm, 1 V_{rms} or less, minimum impedance 32 Ohms, or,
- Stereo headphone/line-out/SPDIF jack, 3.5 mm, 1 V_{rms} or less, minimum impedance 32 Ohms

Microphone

Depending upon your system configuration, you have one of the following:

- Mono microphone jack, 3.5 mm, 100 mV_{p-p} or less, minimum impedance 10K Ohms, or,
- Stereo microphone/line-in jack, 3.5 mm, 100 mV_{p-p} or less, minimum impedance 10K Ohms
- Two built-in stereo speakers, 20 mm diameter

MASS STORAGE DEVICE OPTIONS

Hard Drive

Serial ATA, 150Mbps data buffer, 5400 rpm, 2.5", 9.5 mm

Choice of 40 GB, 60 GB, or 80 GB

Media Player

Depending upon the configuration of your system, one of the following is installed.

- DVD-ROM Drive: 8x maximum read, or,
- Combo DVD/CD-RW Drive: modular 8x maximum DVD/24x maximum write, 10x maximum rewrite, 24x maximum read CD-RW combo drive, or,
- Multi-Format DVD Writer: modular 8x DVD-R, 4x DVD-RW, 8x DVD+R (2.4x Dual-layer DVD+R), 4x DVD+RW, 3x DVD-RAM, 8x DVD-ROM, 16x CD-R, 10x CD-RW, 24x CD-ROM

FEATURES

Integrated Pointing Device

- Touchpad pointing device with scroll button
- Optional Quick Point cursor control button

Communications

Modem: Internal V.90 standard 56K fax/modem (ITU V.90, 56K data, 14.4K fax)

Gigabit LAN: Internal wired 10Base-T/100Base-Tx/1000Base-T) Ethernet LAN

Wireless LAN:

Certain configurations of the Lifebook E8000 notebook have an optional Wireless LAN device installed. If you have an IntelPRO device installed, your system is classified as a Centrino product. If you have no wireless device or a Wireless LAN device other than IntelPRO, your system is classified as a Pentium M product. (For additional information about the Wireless LAN device, refer to the Wireless LAN User's Guide on page 89).

- E8020 Model: Integrated Intel PRO/Wireless 2915ABG (802.11a+b/g), Wi-Fi-compliant
- E8020D Model: Optional integrated Atheros® SuperAG™ Wireless LAN (802.11a+b/g), Wi-Fi-compliant
- Optional Bluetooth device for wireless personal area network communication

Trusted Platform Module

Certain configurations of the LifeBook 8000 notebook have an optional Trusted Platform Module (TPM) installed for added system security.

LifeBook Security/Application Panel

The Application Launcher buttons on your LifeBook notebook default to the following applications:

Table 7-1 Application Launcher Defaults

Button Label	Button Function	Default Application
1	Application A	Notepad
2	Application B	Calculator
3	Internet	Internet Explorer
4	E-Mail	Outlook

Theft Prevention Lock

Lock slot for use with security restraint systems. The Kensington locking system is recommended.

DEVICE PORTS

On the LifeBook notebook:

- PC Card slot for one Type I or Type II card: PCMCIA Standard 2.1 with CardBus support
- ExpressCard slot for one ExpressCard
- MMC/SD Card slot
- One 15-pin D-SUB connector for VGA external monitor (see Display specifications)
- Four USB 2.0 (Universal Serial Bus) connectors for input/output devices
- One serial port (RS-232, D-Sub 9-pin)
- One parallel port (ECP, D-Sub 25-pin)
- One IEEE 1394 (4-pin type) jack
- Infrared port (IrDA1.1, 4 Mbps max.)
- One 7-pin video out jack
- One modular modem (RJ-11) connector
- One LAN (RJ-45) connector
- Docking port (100-pin, to dock with port replicator)
- One stereo headphone/SPDIF jack or one stereo headphone/line-out/SPDIF jack, depending upon system configuration. (See Audio specifications)
- One mono microphone jack or one stereo microphone/line-in jack, depending upon system configuration. (See Audio specifications)
- Embedded Smart Card Reader (requires third-party application)
- Wireless LAN antenna with pre-installed on/off switch
- Optional Bluetooth module with antenna

On the Optional Port Replicator:

- One 6-pin mini DIN PS/2 compatible connectors for external keyboard or mouse
- One 25-pin D-SUB connector for parallel input/output devices; Bi-directional, output only or ECP
- One 15-pin D-SUB connector for VGA external monitor (see Display specifications)
- One 9-pin D-SUB connector for RS-232C serial input/output devices
- Four USB 2.0 connectors for input/output devices
- One LAN (RJ-45) connector
- One DC In connector
- One microphone In jack
- One headphone jack
- One Digital Video (DVI-D) 24-pin, female interface
- One power/suspend/resume button

KEYBOARD

Built-in keyboard with all functions of 101 key PS/2 compatible keyboards.

- Total number of keys: 84
- Function keys: F1 through F12
- Feature extension key: Fn
- Two Windows keys: one Start key, one application key
- Key pitch: 19 mm
- Key stroke: 2.7 mm
- Built-in Touchpad pointing device with left and right buttons and scroll button.
- Built-in Palm Rest
- Optional Quick Point cursor control button

External Keyboard Support

USB or PS/2-compatible (PS/2 compatible with Port Replicator only)

External Mouse Support

USB or PS/2-compatible (PS/2 compatible with Port Replicator only)

POWER

Batteries

One 8-cell Lithium ion battery, rechargeable, 14.4V, 4800 mAh, 69.1 Wh

Optional Flexible Bay battery: 6-cell Lithium ion battery, rechargeable, 10.8V, 3800 mAh, 41 Wh

AC Adapter

Autosensing 100-240V AC, supplying 19V DC, 4.22A, 80W to the LifeBook notebook, Fujitsu Model FPCAC33AP, which includes an AC cable.

Power Management

Conforms to ACPI (Advanced Configuration and Power Interface).

DIMENSIONS AND WEIGHT

Overall Dimensions

Approximately 13.11"(w) x 11.22"(d) x 1.27"/1.49"(h)
(333 mm x 285 mm x 32.2/38.0 mm)

Weights

15" Crystal View XGA model:

- Approximately 7.01 lbs. (3.18kg) with battery and DVD/CD-RW Combo drive
- Approximately 7.05 lbs. (3.20kg) with battery and Multi-Format DVD Writer

15" TFT SXGA+ model:

- Approximately 7.17 lbs. (3.25kg) with battery and DVD/CD-RW Combo drive
- Approximately 7.21 lbs. (3.27kg) with battery and Multi-Format DVD Writer

ENVIRONMENTAL REQUIREMENTS

Temperature

Operating: 41° to 95° F (5° to 35° C)

Non-operating: 5° to 140° F (-15° to 60° C)

Humidity

Operating: 20% to 85%, relative, non-condensing

Non-operating: 8% to 85%, relative, non-condensing

Altitude

Operating: 10,000 feet (3,048 m) maximum

POPULAR ACCESSORIES

For ordering or additional information on Fujitsu accessories please visit our Web site at <http://www.computers.us.fujitsu.com> or call 1-877-372-3473.

Memory Upgrades

- 256 MB SDRAM
- 512 MB SDRAM
- 1GB SDRAM

Docking

- Port Replicator

Power

- Main Lithium ion battery
- Battery Charger
- Auto/Airline Adapter
- AC Adapter

PC Cards

- Wireless PC Card
- 4-in-1 Media Card Adapter
- Compact Flash Media Card Adapter

Additional Accessories

- Wireless Keyboard and Mouse
- External USB Floppy Disk Drive
- Presentation Audio System
- TeleAdapt 16' TeleCord
- Notebook Guardian Lock
- IBM Modem Saver

Carrying Cases

- Diplomat
- Backpack
- Director
- MobileMax Wheeled Case

PRE-INSTALLED SOFTWARE

Depending on your pre-installed operating system, your Fujitsu LifeBook notebook comes with pre-installed software for playing audio and video files of various formats. In addition there is file transfer software, virus protection software and Power Management software. The following list indicates the pre-installed software associated with your system.

- Adobe Acrobat Reader
- Fujitsu HotKey
- LifeBook Security/Application Panel
- Symantec Norton AntiVirus 2004 (90-day free trial)
- Quicken 2005 New User Edition
- InterVideo® WinDVD
- Fujitsu Driver Update utility
- Microsoft Works 8.0 (on select models)

LEARNING ABOUT YOUR SOFTWARE

Tutorials

All operating systems and most application software have tutorials built into them upon installation. We highly recommend that you step through the tutorial before you use an application.

Manuals

Included with your notebook you will find manuals for your installed operating system and other pre-installed software. Any manuals that are not included, are available online through the help system of the software. We recommend that you review these manuals for general information on the use of these applications.

Adobe Acrobat Reader

The Adobe Acrobat Reader allows you to view, navigate, and print PDF files from across all of the major computing platforms.

Fujitsu HotKey

Fujitsu HotKey allows you to control the display brightness of your notebook in order to maximize battery life.

Quicken 2005 New User Edition

Quicken 2005 New User Edition by Intuit is a personal money management program. It has features such as portfolio management, account registries, on-line banking and bill paying. This application is for new users who are using Quicken software for the first time. Full version upgrade information is available on line.

LifeBook Security/Application Panel Software

Your LifeBook notebook is pre-installed with software utilities that let you operate and configure your LifeBook Security/Application Panel.

The Security Panel portion allows for password protection while the system is off or in Suspend mode. The Security Panel utilities are found under the Start menu, under Programs, then under LifeBook Security Panel.

The Application Panel utilities are found under the Start menu, Settings/Control Panel, then Application Panel. To open the CD Player and Application Panel Help, select Start, Programs, LifeBook Application Panel.

Norton AntiVirus 2004

Your system is preinstalled with a free 90-day trial version of Symantec's Norton AntiVirus™ 2004. Norton AntiVirus is a program designed to protect your LifeBook notebook from computer viruses. It assists in the protection of the data currently residing on your hard disk from destruction or contamination. The 90-day trial version is activated upon your acceptance of software license agreement. After 90 days, it will be necessary to purchase a subscription from Symantec to download latest virus definitions.

Fujitsu Driver Update Utility

The Fujitsu Driver Update (FDU) utility is pre-installed on your system. With FDU, you can choose to automatically or manually go to the Fujitsu site to check for new updates for your system. (*See Automatically Downloading Driver Updates on page 65 for more information*).

A large, light gray, stylized number 8 logo. The number 8 is centered within the upper loop of the 8. Below the number 8, the word "Glossary" is written in a bold, black, sans-serif font.

8
Glossary

Glossary

AC Adapter

A device which converts the AC voltage from a wall outlet to the DC voltage needed to power your LifeBook notebook.

ACPI

Advanced Configuration and Power Interface

Active-Matrix Display

A type of technology for making flat-panel displays which has a transistor or similar device for every pixel on the screen.

AdHoc

A name of a wireless LAN configuration.

It is a type of communication using wireless cards only.

Another type of communication is called Infrastructure (using a wireless card and an access point).

ADSL

Asymmetric Digital Subscriber Line

Technology for transporting high bit-rate services over ordinary phone lines.

AGP

Accelerated Graphics Port

Graphics port specifically designed for graphics-intensive devices, such as video cards and 3D accelerators.

Auto/Airline Adapter

A device which converts the DC voltage from an automobile cigarette lighter or aircraft DC power outlet to the DC voltage needed to power your LifeBook notebook.

BIOS

Basic Input-Output System. A program and set of default parameters stored in ROM which tests and operates your LifeBook notebook when you turn it on until it loads your installed operating system from disk. Information from the BIOS is transferred to the installed operating system to provide it with information on the configuration and status of the hardware.

Bit

An abbreviation for binary digit. A single piece of information which is either a one (1) or a zero (0).

bps

An abbreviation for bits per second. Used to describe data transfer rates.

Boot

To start-up a computer and load its operating system from disk, ROM or other storage media into RAM.

Bus

An electrical circuit which passes data between the CPU and the sub-assemblies inside your LifeBook notebook.

Byte

8 bits of parallel binary information.

Cache Memory

A block of memory built into the micro-processor which is much faster to access than your system RAM and used in specially structured ways to make your overall data handling time faster.

CardBus

A faster, 32-bit version of the PC Card interface which offers performance similar to the 32-bit PCI architecture.

CD-ROM

Compact disk read only memory. This is a form of digital data storage which is read optically with a laser rather than a magnetic head. A typical CD-ROM can contain about 600MB of data and is not subject to heads crashing into the surface and destroying the data when there is a failure nor to wear from reading.

Channel

A radio frequency band used for communication between wireless cards and access points.

CMOS RAM

Complementary metal oxide semiconductor random access memory. This is a technology for manufacturing random access memory which requires very low levels of power to operate.

COM Port

Abbreviation for communication port. This is your serial interface connection.

Command

An instruction which you give your operating system. Example: run a particular application or format a floppy disk.

Configuration

The combination of hardware and software that makes up your system and how it is allocated for use.

CRT

Cathode Ray Tube. A display device which uses a beam of electronic particles striking a luminescent screen. It

produces a visual image by varying the position and intensity of the beam.

Data

The information a system stores and processes.

DC

Direct current. A voltage or current that does not fluctuate periodically with time.

Default Value

A pre programmed value to be used if you fail to set your own.

DHCP

Dynamic Host Configuration Protocol

A protocol used to automatically acquire parameters required for the communication, such as IP address.

The sender of IP address is called a DHCP server, and the receiver is called a DHCP client.

DIMM

Dual-in-line memory module.

Disk

A spinning platter of magnetic data storage media. If the platter is very stiff it is a hard drive, if it is highly flexible it is a floppy disk, if it is a floppy disk in a hard housing with a shutter it is commonly called a diskette.

Disk Drive

The hardware which spins the disk and has the heads and control circuitry for reading and writing the data on the disk.

Diskette

A floppy disk in a hard housing with a shutter.

DMA

Direct Memory Access. Special circuitry for memory to memory transfers of data which do not require CPU action.

DMI

Desktop Management Interface. A standard that provides PC management applications with a common method of locally or remotely querying and configuring PC computer systems, hardware and software components, and peripherals.

DNS

Domain Name System

A function to control the association between the IP address and the name assigned to the computer.

If you do not know the IP address but if you know the computer name, you can still communicate to that computer.

DOS

Disk Operating System (MS-DOS is a Microsoft Disk Operating System).

Driver

A computer program which converts application and operating system commands to external devices into the exact form required by a specific brand and model of device in order to produce the desired results from that particular equipment.

DVMT

Dynamic Video Memory Technology

A video memory architecture that increases the efficiency of the motherboard by using innovative memory utilization and direct AGP.

ECP

Extended Capability Port. A set of standards for high speed data communication and interconnection between electronic devices.

Encryption Key (Network Key)

Data encryption key used to encrypt message text and for computing message integrity checks. Data encryption protects data from unauthorized viewing.

This device uses the same encryption key to encode and decode the data, and the identical encryption key is required between the sender and receiver.

ESD

Electro-Static Discharge. The sudden discharge of electricity from a static charge which has built-up slowly. Example: the shock you get from a doorknob on a dry day or the sparks you get from brushing hair on a dry day.

Extended Memory

All memory more than the 640KB recognized by MS-DOS as system memory.

FCC

Federal Communication Commission.

Floppy Disk

A spinning platter of magnetic data storage media which is highly flexible.

GB

Gigabyte.

Hard drive

A spinning platter of magnetic data storage media where the platter is very stiff.

I/O

Input/Output. Data entering and leaving your notebook in electronic form.

I/O Port

The connector and associated control circuits for data entering and leaving your notebook in electronic form.

IDE

Intelligent Drive Electronics. A type of control interface for a hard drive which is inside the hard drive unit.

Infrared

Light just beyond the red portion of the visible light spectrum which is invisible to humans.

Infrastructure

A name of a wireless LAN configuration. This type of communication uses an access point.

Another type of communication is called AdHoc.

IP Address

An identifier for a computer or device on a TCP/IP network. Networks using the TCP/IP protocol route messages based on the IP address of the destination. The format of an IP address is a 32-bit numeric address written as four numbers separated by periods. Each number can be zero to 255. For example, 1.160.10.240 could be an IP address.

Within an isolated network, you can assign IP addresses at random as long as each one is unique. However, connecting a private network to the Internet requires using registered IP addresses (called Internet addresses) to avoid duplicates.

The four numbers in an IP address are used in different ways to identify a particular network and a host on that network. Three regional Internet registries -- ARIN, RIPE NCC and APNIC -- assign Internet addresses from the following three classes.

Class A - supports 16 million hosts on each of 126 networks

Class B - supports 65,000 hosts on each of 16,000 networks

Class C - supports 254 hosts on each of 2 million networks

The number of unassigned Internet addresses is running out, so a new classless scheme called CIDR is gradually

replacing the system based on classes A, B, and C and is tied to adoption of IPv6. (credit: webopedia.com)

IR

An abbreviation for infrared.

IrDA

Infrared Data Association. An organization which produces standards for communication using infrared as the carrier.

IRQ

Interrupt Request. An acronym for the hardware signal to the CPU that an external event has occurred which needs to be processed.

KB

Kilobyte.

LAN

Local Area Network. An interconnection of computers and peripherals within a single limited geographic location which can pass programs and data amongst themselves.

LCD

Liquid Crystal Display. A type of display which makes images by controlling the orientation of crystals in a crystalline liquid.

Lithium ion Battery

A type of rechargeable battery which has a high power-time life for its size and is not subject to the memory effect as Nickel Cadmium batteries.

LPT Port

Line Printer Port. A way of referring to parallel interface ports because historically line printers were the first and latter the most common device connected to parallel ports.

MAC Address

Media Access Control Address

A unique physical address of a network card. For Ethernet, the first three bytes are used as the vendor code, controlled and assigned by IEEE. The remaining three bytes are controlled by each vendor (preventing overlap), therefore, every Ethernet card is given a unique physical address in the world, being assigned with a different address from other cards. For Ethernet, frames are sent and received based on this address.

MB

Megabyte.

Megahertz

1,000,000 cycles per second.

Memory

A repository for data and applications which is readily accessible to your LifeBook notebook's CPU.

MHz

Megahertz.

MIDI

Musical Instrument Digital Interface. A standard communication protocol for exchange of information between computers and sound producers such as synthesizers.

Modem

A contraction for MOdulator-DEModulator. The equipment which connects a computer or other data terminal to a communication line.

Monaural

A system using one channel to process sound from all sources.

MPU-401

A standard for MIDI interfaces and connectors.

MTU

Maximum Transmission Unit

The maximum data size that can be transferred at a time through the Internet or other networks. You can set a smaller MTU size to obtain successful communication, if you have difficulty transferring data due to the fact that the maximum size is too large.

Norton AntiVirus

Web-based software that protects you email, instant messages, and other files by removing viruses, worms, and Trojan horses.

NTSC

National TV Standards Commission. The standard for TV broadcast and reception for the USA.

Operating System

A group of control programs that convert application commands, including driver programs, into the exact form required by a specific brand and model of micro-processor in order to produce the desired results from that particular equipment.

Partition

A block of space on a hard drive which is set aside and made to appear to the operating system as if it were a separate disk, and addressed by the operating system accordingly.

PCI

Peripheral Component Interconnect

Self-configuring PC local bus. Designed by Intel, PCI has gained wide acceptance as a standard bus design.

PCMCIA

PCMCIA is a trademark of the Personal Computer Memory Card International Association. The Personal Computer Memory Card International Association is an organization that sets standards for add-in cards for personal computers.

Peripheral Device

A piece of equipment which performs a specific function associated with but not integral to a computer. Examples: a printer, a modem, a CD-ROM.

Pitch (keyboard)

The distance between the centers of the letter keys of a keyboard.

Pixel

The smallest element of a display, a dot of color on your display screen. The more pixels per area the clearer your image will appear.

POST

Power On Self Test. A program which is part of the BIOS which checks the configuration and operating condition of your hardware whenever power is applied to your notebook. Status and error messages may be displayed before the operating system is loaded. If the self test detects failures that are so serious that operation can not continue, the operating system will not be loaded.

PPPoE

Point to Point Protocol over Ethernet.

A protocol for Ethernet, using a Point-to-Point Protocol (PPP), which is used for connection on the phone line.

Program

An integrated set of coded commands to your computers telling your hardware what to do and how and when to do it.

Protocol

Procedures and rules use to send and receive data between computers.

- Method of sending and receiving data
- Process used to handle communication errors

Conditions required for communication are organized in procedures for correct transfer of information.

RAM

Random Access Memory. A hardware component of your LifeBook notebook that holds binary information (both program and data) as long as it has the proper power applied to it.

RAM Module

A printed circuit card with memory and associated circuitry which allows the user to add additional memory to the computer without special tools.

Reset

The act of reloading the operating system. A reset erases all information stored in RAM.

Restart

See Reset.

Resume

To proceed after interruption. In your notebook this refers to returning to active operation after having been in one of the suspension states.

ROM

Read Only Memory. A form of memory in which information is stored by physically altering the material. Data stored in this way can not be changed by your notebook and does not require power to maintain it.

SDRAM

Synchronous Dynamic Random Access Memory.

Serial Port

A connection to another device through which data is transferred one bit at a time on a single wire with any other wires only for control of the device not for transfer of data.

SMART

Self-Monitoring, Analysis and Reporting Technology (SMART) is an emerging technology that provides near-term failure predictions for hard drives. When SMART is enabled the hard drive monitors pre-determined drive attributes that are susceptible to degradation over time. If a failure is likely to occur, SMART makes a status report available so that the LifeBook notebook can prompt the user to back up the data on the drive. Naturally not all failures are predictable. SMART predictability is limited to those attributes which the drive can

self-monitor. In those cases where SMART can give advance warning, a considerable amount of precious data can be saved.

SRAM

Static random access memory. A specific technology of making RAM which does not require periodic data refreshing.

SSID

Service Set Identifier

Specifies which network you are joining. Some systems allow you to specify any SSID as an option so you can join any network.

Standby

To make inoperative for a period of time. Your LifeBook notebook uses various suspension states to reduce power consumption and prolong the charge of your battery.

Status Indicator

A display which reports the condition of some portion of your hardware. On your LifeBook notebook this is an LCD screen just above the keyboard.

Stereo (audio)

A system using two channels to process sound from two different sources.

SVGA

Super VGA.

S-Video

Super Video. A component video system for driving a TV or computer monitor.

System Clock

An oscillator of fixed precise frequency which synchronizes the operation of the system and is counted to provide time of day and date.

TCP/IP

Transmission Control Protocol/Internet Protocol. A standard Internet protocol that is most widely used.

TFT

Thin Film Transistor – A technology for flat display panels which uses a thin film matrix of transistors to control each pixel of the display screen individually.

UL

Underwriters Laboratories – An independent organization that tests and certifies the electrical safety of devices.

USB

Universal Serial Bus.

Standard that allows you to simultaneously connect up to 127 USB devices such as game pads, pointing devices, printers, and keyboards to your computer.

VGA

Video Graphics Array. A video display standard originally introduced by IBM with the PS/2 series of personal computers.

VRAM

Video Random Access Memory. A memory dedicated to video display data and control.

WFM

Wired for Management is Intel's broad-based initiative to reduce the total cost of ownership (TCO) of business computing without sacrificing power and flexibility.

Wi-Fi Compatible

Wi-Fi (Wireless Fidelity) Identifies that the product has passed the interoperability test, supplied by the WECA (Wireless Ethernet Compatibility Alliance), which guarantees the interoperability of wireless IEEE 802.11 LAN products. For more information on the Wi-Fi standard, go to the WECA Web site at: www.wirelessethernet.com.

WLAN

Wireless Local Area Network. A wireless interconnection of computers and peripherals within a single limited geographic location which can pass programs and data amongst themselves.

Write Protect

Prevent alteration of the binary state of all bits in a storage media. Example: all information on a device such as a floppy diskette; a block of space in a storage media such as a partition of a hard drive; a file or directory of floppy diskette or hard drive.

XGA

Extended VGA.

Zip Drive

A 100MB or 250MB read/write removable media disk drive.

Regulatory Information

NOTICE

Changes or modifications not expressly approved by Fujitsu could void this user's authority to operate the equipment.

FCC NOTICES

Notice to Users of Radios and Television

These limits are designed to provide reasonable protection against harmful interference in a residential installation. This equipment generates, uses, and can radiate radio frequency energy and, if not installed and used in accordance with the instructions, may cause harmful interference to radio communications. However, there is no guarantee that interference will not occur in a particular installation. If this equipment does cause harmful interference to radio or television reception, which can be determined by turning the equipment off and on, the user is encouraged to try to correct the interference by one or more of the following measures:

- Reorient or relocate the receiving antenna.
- Increase the separation between the equipment and receiver.
- Connect the equipment into an outlet that is on a different circuit than the receiver.
- Consult the dealer or an experienced radio/TV technician for help.

Shielded interconnect cables must be employed with this equipment to ensure compliance with the pertinent RF emission limits governing this device.

Notice to Users of the US Telephone Network

This equipment complies with Part 68 of the FCC rules, and the requirements adopted by ACTA. On the bottom of this equipment is a label that contains, among other information, the FCC registration number and ringer equivalence number (REN) for this equipment; or a product identifier in the format US:AAAEQ##TXXXX. If requested, this information or number must be provided to the telephone company.

This equipment is designed to be connected to the telephone network or premises wiring using a standard jack type USOC RJ11C. A plug and jack used to connect this equipment to the premises wiring and telephone network must comply with the applicable FCC Part 68 rules and requirements adopted by the ACTA. A compliant telephone cord and modular plug is provided with this product. It is designed to be connected to a compatible modular jack that is also compliant.

The ringer equivalent number (REN) of this equipment is 0.0B as shown on the label. The REN is used to determine the number of devices that may be connected to a telephone line. Excessive RENs on a telephone may result in the devices not ringing in response to an incoming call. In most but not all areas, the sum of RENs should not exceed five (5.0). To be certain of the number of devices that may be connected to a line, as determined by the total RENs, contact the local telephone company.

If this equipment causes harm to the telephone network, the telephone company will notify you in advance that temporary discontinuance of service may be required. But if advance notice isn't practical, the telephone company will notify the customer as soon as possible. Also, you will be advised of your right to file a complaint with the FCC if you believe it is necessary.

The telephone company may make changes in its facilities, equipment, operations or procedures that could effect the operation of the equipment. If this happens the telephone company will provide advance notice in order for you to make necessary modifications to maintain uninterrupted service.

If trouble is experienced with this equipment, for repair or warranty information, please refer to the manual or contact Fujitsu Computer Systems Corporation, Customer Service. If the equipment is causing harm to the telephone network, the telephone company may request that you disconnect the equipment until the problem is resolved.

The equipment cannot be used on public coin service provided by the telephone company. Connection to party line service is subject to state tariffs. (Contact the state public utility commission, public service commission or corporation commission for information).

If your home has specially wired alarm equipment connected to the telephone line, ensure the installation of this computer does not disable your alarm equipment. If you have any questions about what will disable alarm equipment, consult your telephone company or a qualified installer.

The Telephone Consumer Protection Act of 1991 makes it unlawful for any person to use a computer or other electronic device to send any message via a telephone fax machine unless such message clearly contains in a margin at the top or bottom of each transmitted page or on the first page of the transmission, the date and time it is sent and an identification of the business or other entity, or other individual sending the message and the telephone number of the sending machine or such business, other entity, or individual.

DOC (INDUSTRY CANADA) NOTICES Notice to Users of Radios and Television

This Class B digital apparatus meets all requirements of Canadian Interference-Causing Equipment Regulations.

CET appareil numérique de la class B respecte toutes les exigences du Règlement sur le matériel brouilleur du Canada.

Notice to Users of the Canadian Telephone Network

NOTICE: This equipment meets the applicable Industry Canada Terminal Equipment Technical Specifications.

This is confirmed by the registration number. The abbreviation, IC, before the registration number signifies that registration was performed based on a Declaration of Conformity indicating that Industry Canada technical specifications were met. It does not imply that Industry Canada approved the equipment.

Before connecting this equipment to a telephone line the user should ensure that it is permissible to connect this equipment to the local telecommunication facilities. The user should be aware that compliance with the certification standards does not prevent service degradation in some situations.

Repairs to telecommunication equipment should be made by a Canadian authorized maintenance facility. Any repairs or alterations not expressly approved by Fujitsu or any equipment failures may give the telecommunication company cause to request the user to disconnect the equipment from the telephone line.

NOTICE: The Ringer Equivalence Number (REN) for this terminal equipment is 0.0. The REN assigned to each terminal equipment provides an indication of the maximum number of terminals allowed to be connected to a telephone interface. The termination on an interface may consist of any combination of devices subject only to the requirement that the sum of the Ringer Equivalence Numbers of all the devices does not exceed five.



For safety, users should ensure that the electrical ground of the power utility, the telephone lines and the metallic water pipes are connected together. Users should NOT attempt to make such connections themselves but should contact the appropriate electric inspection authority or electrician. This may be particularly important in rural areas.

Avis Aux Utilisateurs Du Réseau Téléphonique Canadien

AVIS: Le présent matériel est conforme aux spécifications techniques d'Industrie Canada applicables au matériel terminal. Cette conformité est confirmée par le numéro d'enregistrement. Le sigle IC, placé devant le numéro d'enregistrement, signifie que l'enregistrement s'est effectué conformément à une déclaration de conformité et indique que les spécifications techniques d'Industrie Canada ont été respectées. Il n'implique pas qu'Industrie Canada a approuvé le matériel.

Avant de connecter cet équipement à une ligne téléphonique, l'utilisateur doit vérifier s'il est permis de connecter cet équipement aux installations de télécommunications locales. L'utilisateur est averti que même la conformité aux normes de certification ne peut dans certains cas empêcher la dégradation du service.

Les réparations de l'équipement de télécommunications doivent être effectuées par un service de maintenance agréé au Canada. Toute réparation ou modification, qui n'est pas expressément approuvée par Fujitsu, ou toute défaillance de l'équipement peut entraîner la compagnie de télécommunications à exiger que l'utilisateur déconnecte l'équipement de la ligne téléphonique.

AVIS: L'indice d'équivalence de la sonnerie (IES) du présent matériel est de 0.0. L'IES assigné à chaque dispositif terminal indique le nombre maximal de terminaux qui peuvent être raccordés à une interface téléphonique. La terminaison d'une interface peut consister en une combinaison quelconque de dispositifs, à la seule condition que la somme d'indices d'équivalence de la sonnerie de tous les dispositifs n'excède pas 5.



Pour assurer la sécurité, les utilisateurs doivent vérifier que la prise de terre du service d'électricité, les lignes téléphoniques et les conduites d'eau métalliques sont connectées ensemble. Les utilisateurs NE doivent PAS tenter d'établir ces connexions eux-mêmes, mais doivent contacter les services d'inspection d'installations électriques appropriés ou un électricien. Ceci peut être particulièrement important en régions rurales.



Appendix

Integrated Wireless LAN* User's Guide

*** Optional device**

FCC REGULATORY INFORMATION

Please note the following regulatory information related to the wireless LAN device.

Regulatory Notes and Statements

Wireless LAN, Health and Authorization for use

Radio frequency electromagnetic energy is emitted from Wireless LAN devices. The energy levels of these emissions, however, are far much less than the electromagnetic energy emissions from wireless devices such as mobile phones. Wireless LAN devices are safe for use by consumers because they operate within the guidelines found in radio frequency safety standards and recommendations. The use of Wireless LAN devices may be restricted in some situations or environments, such as:

- On board an airplane, or
- In an explosive environment, or
- In situations where the interference risk to other devices or services is perceived or identified as harmful.

In cases in which the policy regarding use of Wireless LAN devices in specific environments is not clear (e.g., airports, hospitals, chemical/oil/gas industrial plants, private buildings), obtain authorization to use these devices prior to operating the equipment.

Regulatory Information/Disclaimers

Installation and use of this Wireless LAN device must be in strict accordance with the instructions included in the user documentation provided with the product. Any changes or modifications made to this device that are not expressly approved by the manufacturer may void the user's authority to operate the equipment. The manufacturer is not responsible for any radio or television interference caused by unauthorized modification of this device, or the substitution or attachment of connecting cables and equipment other than those specified by the manufacturer. It is the responsibility of the user to correct any interference caused by such unauthorized modification, substitution or attachment. The manufacturer and its authorized resellers or distributors will assume no liability for any damage or violation of government regulations arising from failure to comply with these guidelines.

This device must not be co-located or operated in conjunction with any other antenna or transmitter.

For IEEE 802.11a Wireless LAN:

For operation within 5.15~5.25 GHz frequency range, it is restricted to indoor environments, and the antenna of this device must be integral.

Federal Communications Commission statement

This device complies with Part 15 of FCC Rules.

Operation is subject to the following two conditions: (1) This device may not cause interference, and, (2) This device must accept any interference, including interference that may cause undesired operation of this device.

FCC Interference Statement

This equipment has been tested and found to comply with the limits for a Class B digital device, pursuant to Part 15 of the FCC Rules. These limits are designed to provide reasonable protection against harmful interference in a residential installation. This equipment generates, uses, and can radiate radio frequency energy. If not installed and used in accordance with the instructions, it may cause harmful interference to radio communications. However, there is no guarantee that interference will not occur in a particular installation.

If this equipment does cause harmful interference to radio or television reception, which can be determined by turning the equipment off and on, the user is encouraged to try and correct the interference by one or more of the following measures:

1. Reorient or relocate the receiving antenna.
2. Increase the distance between the equipment and the receiver.
3. Connect the equipment to an outlet on a circuit different from the one the receiver is connected to.
4. Consult the dealer or an experienced radio/TV technician for help.

FCC Radio Frequency Exposure statement

This equipment complies with FCC radiation exposure limits set forth for an uncontrolled environment. This equipment should be installed and operated with a minimum distance of 20 centimeters between the Wireless LAN antenna (located on the top edge of the LCD screen) and your body. The Bluetooth antenna is located on the right hinge of the LCD screen and is exempt from minimum distance criteria due to its low power. The transmitters in this device must not be co-located or operated in conjunction with any other antenna or transmitter.

Export restrictions

This product or software contains encryption code which may not be exported or transferred from the US or Canada without an approved US Department of Commerce export license. This device complies with Part 15 of FCC Rules., as well as ICES 003 B / NMB 003 B. Operation is subject to the following two conditions: (1) this device may not cause harmful interference, and (2) this device must accept any interference received, including interference that may cause undesirable operation. Modifications not expressly authorized by Fujitsu Computer Systems Corporation may invalidate the user's right to operate this equipment.

Canadian Notice

To prevent radio interference to the licensed service, this device is intended to be operated indoors and away from windows to provide maximum shielding. Equipment (or its transmit antenna) that is installed outdoors is subject to licensing.

Before Using the Wireless LAN

This manual describes the procedures required to properly setup and configure the integrated Wireless LAN Mini-PCI device (referred to as "WLAN device" in the rest of the manual). Before using the WLAN device, read this manual carefully to ensure it's correct operation. Keep this manual in a safe place for future reference.

Wireless LAN Devices Covered by this Document

This document is applicable to systems containing one of the following two devices. Most of the procedures are identical. Sections that differ between the two devices have been noted in the text:

- Intel PRO/Wireless 2915ABG
- Atheros® SuperAG™ Wireless LAN

If your system is an E8020, your wireless module is the Intel PROSet wireless LAN; if your system is an E8020D, your wireless module is the Atheros wireless LAN.

Characteristics of the WLAN Device

- The WLAN device is a Mini-PCI card attached to the mainboard of the mobile computer.
- It operates in two license-free RF bands, therefore eliminating the need to procure an FCC license to operate. It operates in the 2.4GHz Industrial, Scientific, and Medical (ISM) RF band and in the lower and middle bands of the 5GHz Unlicensed National Information Infrastructure (UNII) bands.
- The WLANs are capable of three operating modes, IEEE802.11a, IEEE802.11b and IEEE802.11g, wireless LAN standards governed by the IEEE (Institute of Electronics and Electrical Engineers).

- Encoding of data is modulated using Direct Sequence Spread Spectrum (DSSS) and Complementary Code Keying (CCK) when the WLAN device is operating in IEEE 802.11b mode and Orthogonal Frequency Division Multiplexing (OFDM) when operating in IEEE802.11a or IEEE802.11g mode.
- The WLAN device is Wi-Fi certified and operates at the maximum data transfer rate of 54 Mbps in IEEE802.11a or IEEE802.11g mode and 11 Mbps in IEEE802.11b mode.
- The maximum communication range indoors is approximately 80 feet (25 meters). However, that range will increase or decrease depending on factors such as number of walls, reflective material, or interference from external RF sources.
- The WLAN device supports the following encryption methods - WEP, TKIP, and AES encryption.

WIRELESS LAN MODES USING THIS DEVICE

Ad Hoc Mode

(See Figure A-1)

"Ad Hoc Mode" refers to a wireless network architecture where wireless network connectivity between multiple computers is established without a central wireless network device, typically known as Access Point(s). Connectivity is accomplished using only client devices in a peer-to-peer fashion. That is why Ad Hoc networks are also known as peer-to-peer networks. Ad Hoc networks are an easy and inexpensive method for establishing network connectivity between multiple computers.

Ad Hoc mode requires that the SSID, network authentication, and encryption key settings are identically configured on all computers in the Ad Hoc network.

Figure A-1. Ad Hoc Mode Network

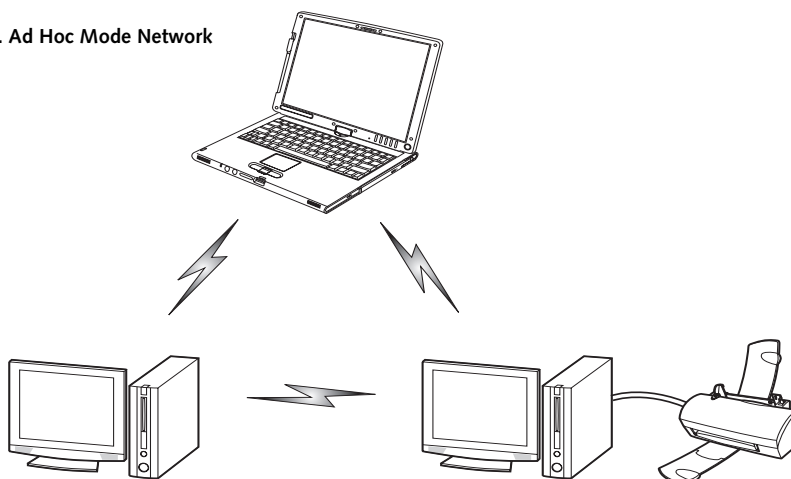

Access Point (Infrastructure) Mode

(See Figure A-2)

Infrastructure mode refers to a wireless network architecture in which devices communicate with wireless or wired network devices through an Access Point. In infrastructure mode, wireless devices can communicate with each other or with a wired network. Corporate wireless networks operate in infrastructure mode because they require access to the wired LAN in order to access computers, devices, and services such as file servers, printers, and databases.

How to Handle This Device

The WLAN device comes pre-installed in your mobile computer. Under normal circumstances, it should not be necessary for you to remove or re-install it. The Operating System that your mobile computer comes with has been pre-configured to support the WLAN device.

WIRELESS NETWORK CONSIDERATIONS

- The WLAN devices support IEEE802.11a+b/g.
- The devices operate in the 2.4GHz ISM band the 5 GHz lower and middle UNII bands.
- The maximum range of the WLAN device indoors is typically 80 feet (25 meters). Please note that the maximum range you achieve may be shorter or longer than 80 feet, depending on factors such as access point transmit power, number and density of obstructions, or external RF interference.

- Microwave ovens will interfere with the operation of WLAN device as microwave ovens operate in the same 2.4GHz frequency range that IEEE802.11b/g devices operate in. Interference by microwaves does not occur with IEEE802.11a radio which operates in the 5 GHz RF band.
- Wireless devices that transmit in the 2.4 GHz frequency range may interfere with the operation of WLAN devices in IEEE802.11b/g modes. Interference symptoms include reduced throughput, intermittent disconnects, and large amounts of frame errors. It is HIGHLY recommended that interfering devices be powered off to ensure proper operation of the WLAN.

DEACTIVATING THE WLAN DEVICE

Deactivation of the WLAN device may be desired in certain circumstances (to extend battery life) or where certain environments require it (i.e. hospitals, clinics, airplanes, etc.). Fujitsu mobile computers employ two methods with which to deactivate the WLAN device:

- Using the Wireless On/Off Switch, or,
- In Windows, using the Intel PROSet Software or Atheros Client Utility software.

Deactivation using the Wireless On/Off Switch

The WLAN device can be deactivated quickly and efficiently by toggling the Wireless On/Off Switch to the Off position. (Figure A-3)

The wireless On/Off switch has no effect on non-Wireless LAN models.

Figure A-2. Access Point (Infrastructure) Mode Network

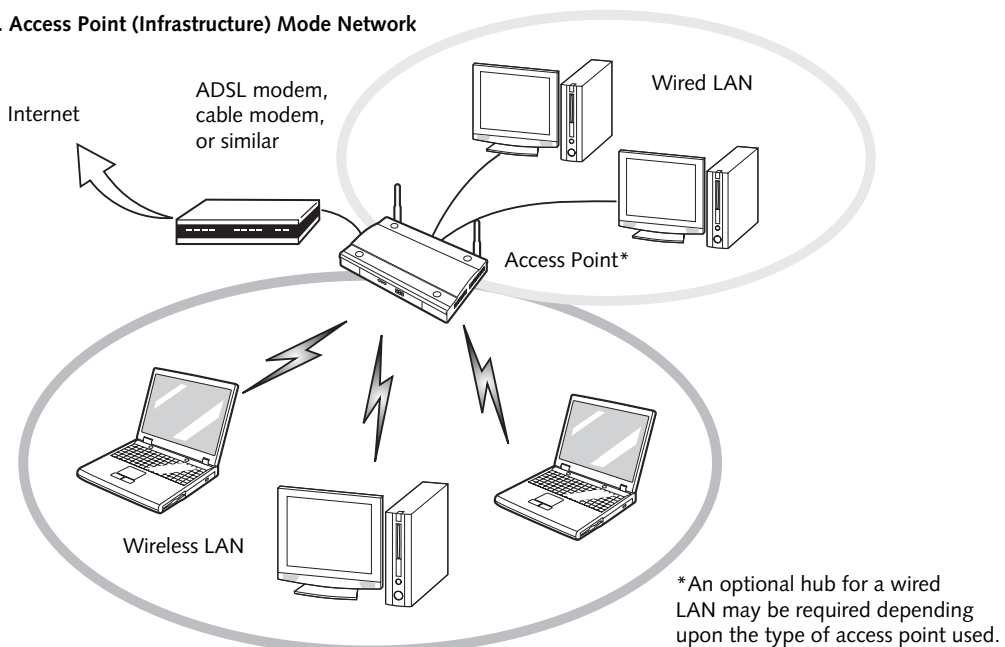

The Wireless LAN/Bluetooth On/Off Switch will power off both the optional wireless LAN and Bluetooth devices at the same time. To enable or disable either one of the devices individually, perform the following steps:



1. Slide the Wireless LAN/Bluetooth on/off switch to On position.
2. In the Control Panel, double-click the Fujitsu Radio Control icon.
3. In the window that appears, click the button associated with Bluetooth and/or Wireless LAN Status to enable or disable the individual devices.
4. Click [OK].

The Wireless LAN/Bluetooth On/Off switch has no effect on systems without wireless devices.

Wireless LAN/Bluetooth
On/Off Switch

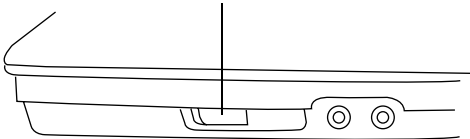

Figure A-3. Wireless LAN On/Off Switch Location

Deactivation using the Intel PROSet Software

The WLAN device can also be deactivated in Windows using the Intel PROSet Software. The procedure to accomplish this:

1. Click [Start]-> [All Programs].
2. Select Intel ProSet Wireless, then click on Intel ProSet Wireless from the menu that appears. The Intel ProSet Wireless utility will be displayed.
3. At the bottom left corner of the window, select Wireless Off from the dropdown list.

Deactivation using Atheros Client Utility software

1. Click [Start] -> [Program Files] -> [Atheros] -> Atheros Client Utility.
2. Choose Action and click Disable Radio.

ACTIVATING THE WLAN DEVICE

Activation of the WLAN device can be accomplished using the same methods as the deactivation process

- Using the Wireless On/Off Switch
- In Windows using the Intel PROSet Software or Atheros Software.

Configuration of the WLAN Device

The WLAN Device can be configured to establish wireless network connectivity using one of the following tools:

- Windows XP Wireless Zero Configuration (WZC) - The WZC allows for multiple profile setup and support for most industry standard security solutions.
- Intel PROSet Software - The Intel PROSet Software allows for multiple profile setup and supports automatic profile switching. Support for most industry standard security solutions as well as Cisco Compatible Extensions (CCX) is contained in this software.
- Atheros Client Utility - The Atheros Client Utility software allows for multiple profile setups and supports automatic profile switching. Support for most industry standard security solutions, as well as Cisco Compatible Extensions (CCX), is contained in this software.

FLOW OF OPERATIONS

1. Activate the WLAN Device (See Activating the WLAN Device on page 94 for more information).
2. Configure the Wireless Network parameters (Depending upon the configuration tool or utility you are using, see the appropriate section below).
 - Enter the network name (SSID)
 - Choose the appropriate WLAN architecture (Ad Hoc or Infrastructure)
 - Choose Authentication method: Open, Shared, WPA, or WPA-PSK
 - If using static WEP keys, enter static WEP key and choose key index.
3. Configure network settings (Depending upon the configuration tool or utility you are using, see the appropriate section below).
 - TCP/IP settings
 - Workgroup or Domain settings.

CONFIGURATION USING WIRELESS ZERO CONFIGURATION TOOL

This section explains the procedure to properly configure the WLAN device using the WZC. Pre-defined parameters will be required for this procedure. Please consult with your network administrator for these parameters:

Network Name - Also known as the SSID

Network Key (WEP) - Required if using static WEP keys.

Authentication Type - Open, Shared, WPA, or WPA-PSK

Procedure

1. Activate the WLAN device using the Wireless On/Off Switch, the Intel PROSet software, or the Atheros Client Utility.
2. Click the [Start] button first and then [Control Panel].
3. If the Control Panel is in Category view, switch to Classic view by clicking "Switch to Classic View" which can be found in the left frame of the Control Panel window.
4. Double-click the Network Connections icon. A list of previously configured networks will be displayed.
5. Right-click [Wireless Network Connection] in the list, and then click [Properties] in the menu displayed.
6. Click the [Wireless Networks] tab.
7. Click [Refresh], then choose the correct SSID from the [Available Networks] window. Click [Configure] and proceed to step 8. Please note that only wireless networks that broadcast their SSID will be displayed. If the SSID of the wireless network is not visible, you must manually add it. This can be accomplished by clicking [Add]
8. From within the Association tab configure the appropriate WLAN parameters. Please have ready the following parameters:
 - Network name (SSID) - ASCII string of up to 33 characters used by the WLAN to logically separate wireless networks.
 - Authentication Type - Options include Open, Shared, WPA, or WPA-PSK
 - Network Key - If Authentication Type is Open or Shared, choices are None or WEP. If Authentication Type is WPA or WPA-PSK, choices are WEP or TKIP.

Ad Hoc Networks: All computers in an Ad Hoc network must be assigned with the same SSID and the checkbox for the field [This is a computer to computer (ad hoc) network, wireless access points are not used.] must be checked.

Access Point (Infrastructure) Networks: The SSID must be identical to the SSID of the access point(s) and the checkbox for the following field must be unchecked [This is a computer to computer (ad hoc) network wireless access points are not used.] Refer to the access point manual, or contact your network administrator

9. Configure Wireless Network Key parameters (Network Authentication and Encryption).

a. Choose the Network Authentication method appropriate for your wireless LAN. Options include Open, Shared, WPA, and WPA-PSK.

Ad Hoc Networks: Network Authentication settings must be identical for all computers in the Ad Hoc network.

Access Point (Infrastructure Networks): Network Authentication setting must be configured to match the setting of the Access Point(s). Please contact your network administrator for this information.

b. Choose the Encryption method appropriate for your wireless LAN. Options for Open or Shared Authentication are None or WEP. Options for WPA or WPA-PSK are WEP or TKIP.

c. If using static WEP keys, clear the check mark from the [The key is provided for me automatically] check box. If using an authentication method that uses dynamic WEP (e.g., WPA, WPA-PSK, 802.1x/EAP), the check box should remain checked. Please contact your network administrator for the correct settings.

d. Static WEP keys (if applicable) are entered in the [Network Key] box. Configuration of the [Network Key] is not required if the [The key is provided for me automatically] check box is checked.

- Static WEP keys entered in ASCII code format will be either five characters (40-bit) or thirteen characters (104-bit) in length. Valid characters are 0 - 9, A - Z.
- Static WEP keys entered in hexadecimal code format will be either ten characters

(40-bit) or twenty-six characters (104-bit) in length. Valid characters are 0 - 9, A - F.

Ad Hoc Networks: Assign the same network key to all the personal computers to be connected.

Access Point (Infrastructure) Networks: Assign the identical network key that is programmed into the access point. Please contact your network administrator for this information.

e. If using static WEP keys, confirm the Network key by re-entering the same data in the [Confirm network key:] field.

f. The Key index used must be identical to the transmit key used in the Access Point or other wireless device. This is only applicable when static WEP keys are used. Please contact your network administrator for this information.

10. **Access Point (Infrastructure) Networks Only:** If the wireless network you are establishing connectivity to implements an access control security mechanism, configuration of 802.1x parameters may be necessary. Please contact your network administrator for these settings. Configuration of these parameters is not applicable to home users.

11. Click [OK] to close the [Wireless Network] window which will cause the WLAN device to re-establish wireless network connectivity using the recently configured parameters.

CONFIGURATION USING INTEL PROSET SOFTWARE

This section explains the procedure to properly configure the WLAN device using the Intel PROSet Software. Pre-defined parameters will be required for this procedure. Please consult with your network administrator for these parameters:

Network Name - Also known as the SSID

Network Key (WEP) - Required if using static WEP keys.

Authentication Type - Open, Shared, WPA, or WPA-PSK

Procedure

1. Activate the WLAN device using either the Wireless On/Off Switch or the Intel PROSet software.
2. Click the [Start] button first and then [Control Panel].
3. If the Control Panel is in Category view, switch to Classic view by clicking "Switch to Classic View"

- which can be found in the left frame of the Control Panel window.
4. Double-click the icon [Intel PROSet] to execute the Intel PROSet Software.
 5. From the General page, click the Networks tab.
 6. Click the [Add] button. The General Settings dialog displays.
 7. From the General page, click the Networks tab.
 8. Click the [Add] button. The General Settings dialog displays.
 9. Enter a profile name in the Profile Name field.
 10. Enter the network SSID, in the Network Name (SSID) field.
 11. Click Infrastructure or Ad Hoc for the operating mode.
 12. The Mandatory AP option is only used if Infrastructure mode is selected. Use this option to connect to a specific access point. Click the Mandatory AP button, enter the MAC address for the access point. Click OK to save the setting and return to the General Settings page.
 13. If you are using Cisco CCX, click the Enable Cisco Client eXtentions option to enable Cisco CKIP data encryption on the Security Settings page. If you have checked the Cisco's "Mixed-Cell" box in the Advanced Setting, this option must also be checked.
 14. Click Next.
 15. Click the Security tab
 16. Select Open, Shared, WPA, or WPA-PSK in the Network Authentication options.
 17. Select either None, WEP, CKIP (if Enable Cisco Client eXtentions is enabled on the General Settings page), or TKIP for the data encryption.
 18. If WEP is selected, select either 64 or 128-bit for the Encryption Level.
 19. Select the key index 1, 2, 3 or 4.
 20. Enter the WEP key if required. If your network does not employ a 802.1x/EAP security mechanism, please skip to step 24.
 21. Click the 802.1x Enabled checkbox to enable the 802.1x security option. Please contact your network administrator if configuration of this setting is required.
 22. Select the appropriate 802.1x/EAP Type. Please contact your network administrator if configuration of this setting is required.
 23. After selecting your authentication type, click the Configure button to open the Settings dialog. Enter the user name and password of the user you have created on the authentication server. The user name and password do not have to be the same as name and password of your current Windows user login. The "Server Identity" can be use the default setting. The "Client Certificate" should be the one obtained from your RADIUS server or other certification server.
 24. Click Close to save the settings.
 25. From the General settings page, click the new profile name shown in the Profile List. Use the up and down arrows to position the priority of the new profile in the priority list.
 26. Click the Advanced button to set the network connection preferences.
 27. Click the Connect button to connect to the network.
 28. Click OK to close the Intel(R) PROSet for Wireless utility

CONFIGURATION USING Atheros CLIENT UTILITY SOFTWARE

This section explains the procedure to properly configure the WLAN device using the Atheros Client Utility. Pre-defined parameters will be required for this procedure. Please consult with your network administrator for these parameters:

Network Name - Also known as the SSID

Network Key (WEP) - Required if using static WEP keys.

Authentication Type - Open, Shared, WPA, or WPA-PSK

Procedure

1. Activate the WLAN device using either the Wireless On/Off Switch or the Atheros Client Utility
2. Click the [Start] button first and then [Control Panel].
3. If the Control Panel is in Category view, switch to Classic view by clicking "Switch to Classic View" which can be found in the left frame of the Control Panel window.
4. Double-click the icon [Atheros Client Utility] to execute the Atheros Client Utility.

5. From the Current Status page, click the Profile Management tab.
6. If this is your first time using this utility, highlight the profile [Default] and Click the [Modify] button, otherwise Click the [New] button. The General Settings dialog displays.
7. From the General page, enter a profile name in the Profile Name field.
8. Enter the network SSID, in the SSID1 field. If you wish to create a profile that can connect to up to 3 different wireless networks, SSID's can be entered in the SSID2 and SSID3 fields as well.
9. Click the Security tab.
10. The Security tab allows for the configuration of the Security modes listed in the table below. Please select the radio button of the desired security mode. If these settings are not known to you, please consult with your network administrator for the correct settings.

Field Name	Description
WPA	Enables the use of Wi-Fi Protected Access. Choosing WPA opens the WPA EAP drop-down menu. Options include TLS and PEAP. If these settings are not known to you, please consult with your network administrator for the correct settings.
WPA-PSK	Enables WPA-Pre-Shared Key. Click on the Configure button to enter the WPA Passphrase. If these settings are not known to you, please consult with your network administrator for the correct settings.
802.1x	Enables 802.1x security. If these settings are not known to you, please consult with your network administrator for the correct settings. Choosing this option opens the 802.1x EAP type drop-down menu. Options include TLS, PEAP, and LEAP
Pre-Shared Key	Enables the use of pre-shared keys that are defined on both the access point and the station. This is where static WEP keys are entered. Click the Configure button to fill in the Define Pre-Shared Keys window.
None	No security

11. Click OK
12. Click the Advanced tab

13. The Advanced tab allows for the configuration of the options detailed in the table below.

Field Name	Description
Power Save Mode	Options are Maximum, Normal, or Off
Network Type	Options are AP (Infrastructure) or Ad Hoc
802.11b Preamble	Specifies the preamble setting in 802.11b. The default setting is Short and Long (Access Point mode), which allows both short and long headers in the 802.11b frames. Set to Long Only to override allowing short frames.
Transmit Power Level	Options are 100%, 50%, 25%, 12.5% or Lowest transmit power (0mW)
Wireless Mode	Specifies 5 GHz 54 Mbps, 5 GHz 108 Mbps, 2.4 GHz 11 Mbps, or 2.4 GHz 54 Mbps operation in an access point network.
Wireless Mode when Starting Ad Hoc Network	Specifies 5GHz 54 Mbps, 5 GHz 108 Mbps, 2.4 GHz 11 Mbps, or 2.4 GHz 54 Mbps to start an Ad Hoc network if no matching network name is found after scanning all available modes.

14. Click OK
15. If the profile you just created does not activate immediately, click the Profile Management tab, highlight the desired Profile, and click Activate.
16. Click OK to close the Atheros Client Utility.

CONNECTION TO THE NETWORK

This section explains connection to the network.

If there is an administrator of the network, contact the network administrator for data settings.

Setting the network

Perform the “Setting TCP/IP” and “Confirming the computer and work group names” operations required for network connection.

Setting TCP/IP



To change the setting of the IP address, you need to be logged in from Windows as an administrator.

1. Click the [Start] button first and then [Control Panel].
2. If the Control Panel is in Category view, switch to Classic view by clicking “Switch to Classic View” under Control Panel the left frame. (If you are already in Classic view, “Switch to Category View” will be displayed.)
3. Double-click [Network Connections]. A list of currently installed networks will be displayed.
4. Right-click [Wireless Network Connection] in the list, and then click [Properties] in the menu displayed. The [Wireless Network Connection Properties] window will be displayed.
5. Click the [General] tab if it is not already selected.
6. Click [Internet Protocol (TCP/IP)] and then click [Properties]. The [Internet Protocol (TCP/IP) Properties] window will be displayed.
7. Set the IP address as follows:
 - **For ad hoc connection:** Select [Use the following IP address:] and then enter data for [IP address] and [Subnet mask]. See page 105 for IP address setting.
 - **For access point (infrastructure) connection:** If your network uses DHCP, select [Obtain an IP address automatically] and [Obtain DNS server address automatically]. If your network uses static IP addresses, consult with your network administrator for the correct IP address settings.
8. Click the [OK] button. Processing will return to the [Wireless Network Connection Properties] window.
9. Click the [OK] button.
10. Close the [Network Connection] window.

Following this operation, confirm the names of the computer and the workgroup as follows.

Confirming the computer and work group names



To modify the computer name and/or the work group name, you need to be logged in from Windows as an administrator.

1. Click the [Start] button, then [Control Panel].
2. If the Control Panel is in Category view, switch to Classic view by clicking “Switch to Classic View” under Control Panel the left frame. (If you are already in Classic view, “Switch to Category View” will be displayed.)
3. Double-click the [System] icon. The [System Properties] window will be displayed.
4. Click the [Computer Name] tab.
5. Confirm the settings of [Full computer name:] and [Workgroup:].
 - a. The setting of [Full computer name:] denotes the name for identifying the computer. Any name can be assigned for each personal computer.



To change the name, click [Change] and then proceed in accordance with the instruction messages displayed on the screen.

Enter the desired name in less than 15 ASCII character code format. Identifiability can be enhanced by entering the model number, the user name, and other factors.

- b. [Workgroup name] is the group name of the network. Enter the desired name in less than 15 ASCII character code format.

For ad hoc connection: Assign the same network name to all personal computers existing on the network.

For access point (infrastructure) connection: Assign the name of the work group to be accessed.

6. Click the [OK] button. If a message is displayed that requests you to restart the personal computer, click [Yes] to restart the computer.

Setting the sharing function

Set the sharing function to make file and/or printer sharing with other network-connected personal computers valid.

This operation is not required unless the sharing function is to be used.

The folder and printer for which the sharing function has been set will be usable from any personal computer present on the network.



To share a file and/or the connected printer, you need to be logged in as an administrator.

Setting the Microsoft network-sharing service

1. Click the [Start] button first and then [Control Panel].
2. If the Control Panel is in Category view, switch to Classic view by clicking “Switch to Classic View” under Control Panel the left frame. (If you are already in Classic view, “Switch to Category View” will be displayed.)
3. Double-click [Network Connections]. A list of currently installed networks will be displayed.
4. Right-click [Wireless Network Connection] in the list, and then click [Properties] in the menu displayed. The [Wireless Network Connection Properties] window will be displayed.
5. If [File and Printer Sharing for Microsoft Networks] is displayed, proceed to step 6. If [File and Printer Sharing for Microsoft Networks] is not displayed, skip to step 7.
6. Make sure that the [File and Printer Sharing for Microsoft Networks] check box is checked, and then click the [OK] button. Skip to “Setting file-sharing function”.
7. Click [Install]. The [Select Network Component Type] window will be displayed.
8. Click [Service], then click the [Add] button. The [Select Network Service] window will be displayed.
9. Click [File and Printer Sharing for Microsoft Networks] and then click the [OK] button. Processing will return to the [Wireless Network Connection Properties] window, and [File and Printer Sharing for Microsoft Networks] will be added to the list.
10. Click the [Close] button.

Setting the file-sharing function

The procedure for setting the file-sharing function follows, with the “work” folder in drive C: as an example.

1. Click the [Start] button first and then [My Computer].
2. Double-click [Local disk (C:)].

3. Right-click the “work” folder (or whichever folder you want to share), and then click [Sharing and Security...] in the menu displayed. The [Folder Name Properties] window will be displayed.



Setting the file-sharing function for the file which has been used to execute Network Setup Wizard is suggested on the screen. For the wireless LAN, however, since security is guaranteed by entry of the network name (SSID) and the network key, the steps to be taken to set the file-sharing function easily without using Network Setup Wizard are given below.

4. Click [Sharing] if it isn’t already selected.
5. Click the link stating “If you understand the security risks, but want to share files without running the wizard, click here”.
6. Click “Just enable file sharing” and click [OK].
7. Check the [Share this folder on the network] check box.



To specify the corresponding folder as a read-only folder, select the [Read only] checkbox under the General tab.

8. Click the [OK] button. The folder will be set as a sharable folder, and the display of the icon for the “work.” folder will change.

Setting the printer-sharing function

1. Click the [Start] button first and then [Printers and FAX]. A list of connected printers will be displayed.
2. Right-click the printer for which the sharing function is to be set, and then click [Sharing] in the menu displayed. The property window corresponding to the selected printer will be displayed.



Setting the printer-sharing function when Network Setup Wizard has been executed is suggested on the screen. For the wireless LAN, however, since security is guaranteed by entry of the network name (SSID) and the network key, the steps to be taken to set the printer-sharing function without using Network Setup Wizard are laid down below.

3. Click the [Sharing] tab.
4. Click [Share this printer].
5. Enter the sharing printer name in [Share name].
6. Click the [OK] button.

Confirming connection

After you have finished the network setup operations, access the folder whose sharing has been set for other personal computers. Also, confirm the status of the radio waves in case of trouble such as a network connection failure.



In the case of access point (infrastructure) connection, enter the necessary data for the access point before confirming connection. Refer to the manual of the access point for the access point setup procedure.

Connecting your personal computer to another personal computer

1. Click [Start] first and then [My Computer]. The [My Computer] window will be displayed in the left frame.
2. Click [My Network Places] in the "Other Places" list. The window [My Network Places] will be displayed.
3. Click [View workgroup computers] under Network Tasks in the left frame.
4. Double-click the personal computer to which your personal computer is to be connected. The folder that was specified in "Setting the file-sharing function" on page 100 will be displayed.
5. Double-click the folder to be accessed.

Confirming the status of the radio

1. Right-click the Intel PRO Wireless icon in the lower right corner of the screen.
2. Click [Open Intel PROSet for Wireless]. The Intel PROSet for Wireless window opens.
3. Contained within the General tab and the Details section (accessed by pressing the [Details] button), you will find the current operating status of the radio. (When the radio is turned off or the computer is not yet connected, some of the conditions will not be displayed.)
 - **Network Name (SSID)**
Displays the Network Name (SSID) currently used by the radio.

- **Profile Name**
The current configuration profile is displayed.
- **Mode**
Displays the current operating mode. [Infrastructure (AP)] or [Ad Hoc] will be displayed.
- **Security**
Displays the current security status of the profile being used:
None: No encryption used.
WEP: WEP encryption algorithm used.
CKIP: WEP encryption algorithm used.
TKIP: WEP encryption algorithm used.
- **Speed**
Displays the highest data rate of the associated access point in mega-bits-per-second (Mbps) until data transfer occurs.
802.11g: 1, 2, 5.5, 6, 9, 11, 12, 18, 24, 36, 48, or 54.
802.11b: 1, 2, 5.5, or 11.
- **Band (Frequency)**
Displays the current band and frequency being used. Displays Out of Range if no band and frequency is displayed. Displays:
802.11g (2.4 GHz) or 802.11b (2.4 GHz)
- **Channel**
Displays the current transmit and receive channel being used.
- **802.1x Protocol**
Displays Enabled if the profile uses 802.1x authentication. Default is Disabled.

Troubleshooting

Causes and countermeasures for troubles you may encounter while using your wireless LAN are described in the following table.

Problem	Possible Cause	Possible Solution
Unavailable network connection	Incorrect network name (SSID) or network key	<p>Ad hoc connection: verify that the network names (SSID's) and network keys (WEP) of all computers to be connected have been configured correctly. SSID's and WEP key values must be identical on each machine.</p> <p>Access Point (Infrastructure) connection: set the network name (SSID) and network key to the same values as those of the access point.</p> <p>Set the Network Authentication value identically to that of the Access Point. Please consult your network administrator for this value, if necessary.</p> <p>For the method of setting network authentication, refer to the section of this chapter related to the configuration tool or utility you are using.</p>
	Weak received signal strength and/or link quality	<p>Ad hoc connection: Retry connection after shortening the distance to the destination computer or removing any obstacles for better sight.</p> <p>Access Point (Infrastructure) connection: Retry connection after shortening the distance to the access point or removing any obstacles for better sight.</p> <p><i>(See Confirming connection on page 101 for more information).</i></p>
	The WLAN device has been deactivated or disabled	Check if the wireless switch is turned ON. Also verify "Disable Radio" is not checked in "Network setting" window. <i>(See Activating the WLAN Device on page 94 for more information).</i>
	The computer to be connected is turned off	Check if the computer to be connected is turned ON.
	RF interference from Access Points or other wireless networks	The use of identical or overlapping RF channels can cause interference with the operation of the WLAN device. Change the channel of your Access Point to a channel that does not overlap with the interfering device.
	Wireless network authentication has failed	Re-check your Network Authentication, Encryption, and Security settings. Incorrectly configured security settings such as an incorrectly typed WEP key, a mis-configured LEAP username, or an incorrectly chosen authentication method will cause the LAN device to associate but not authenticate to the wireless network.
	Incorrectly configured network settings	Recheck the configuration of your network settings. For the method of checking, refer to the following page: "Connection to the Network" on page 99.
	Incorrect IP address configuration	This only applies to networks using static IP addresses. Please contact your network administrator for the correct settings.

Wireless LAN Glossary

Ad Hoc Mode

Ad Hoc Mode refers to a wireless network architecture where wireless network connectivity between multiple computers is established without a central wireless network device, typically known as Access Points. Connectivity is accomplished using only client devices in a peer-to-peer fashion. For details, refer to “Ad hoc connection” on page 92.

Channel

Range of narrow-band frequencies used by the WLAN device to transmit data. IEEE802.11b/g - 11 channels, 22 MHz wide channels.

DHCP (Dynamic Host Configuration Protocol)

A protocol that provides a means to dynamically allocate IP addresses to computers on a local area network.

DNS (Domain Name System)

A data query service that provides a mechanism with which to translate host names into Internet addresses.

IEEE802.11a

Wireless LAN standard that supports a maximum data rate of 54 Mbps. 802.11a devices operate in the 5 GHz lower and middle UNII bands.

IEEE802.11b

Wireless LAN standard that supports a maximum data rate of 11 Mbps. 802.11b devices operate in the 2.4 GHz ISM band.

Access point

Wireless network device used to bridge wireless and wired network traffic.

IP address

The logical 32-bit host address defined by the Internet Protocol that uniquely identifies a computer on a network. The IP address is usually expressed in dotted decimal notation.

LAN (Local Area Network)

A LAN or Local Area Network is a computer network (or data communications network) which is confined to a limited geographical area.

MAC address (Media Access Control Address)

A MAC address (also called an Ethernet address or IEEE MAC address) is the 48-bit address (typically written as twelve hexadecimal digits, 0 through 9 and A through F, or as six hexadecimal numbers separated by periods or colons, e.g., 0080002012ef, 0:80:0:2:20:ef) which uniquely identifies a computer that has an Ethernet interface.

MTU (Maximum Transmission Unit)

The maximum size of data which can be transmitted at one time in networks including the Internet. In an environment whose maximum size of data is too large to correctly receive data, normal communications can be restored by setting the size of MTU to a smaller value.

Network key

Data that is used for encrypting data in data communication. The personal computer uses the same network key both for data encryption and decryption, therefore, it is necessary to set the same network key as the other side of communication.

Network name (SSID: Security Set Identifier)

When a wireless LAN network is configured, grouping is performed to avoid interference or data theft. This grouping is performed with “Network name (SSID)”. In order to improve security, the network key is set allowing no communication unless “Network name (SSID)” coincides with the network key.

Open system authentication

Null authentication method specified in the 802.11 standard that performs no authentication checks on a wireless client before allowing it to associate.

PPPoE (Point to Point Protocol over Ethernet)

A method of allowing the authentication protocol adopted in telephone line connection (PPP) to be used over an Ethernet.

Protocol

A procedure or rule of delivering data among computers. Ordered data communication is allowed by making all conditions required for communication including the method of data transmission/reception and actions upon communication errors into procedures.

Shared key authentication

802.11 network authentication method in which the AP sends the client device a challenge text packet that the client must then encrypt with the correct WEP key and return to the AP. If the client has the wrong key or no key, authentication will fail and the client will not be allowed to associate with the AP. Shared key authentication is not considered secure, because a hacker who detects both the clear-text challenge and the same challenge encrypted with a WEP key can decipher the WEP key.

SSID (Service Set Identifier)

Service Set Identifier, a 32-character unique identifier attached to the header of packets sent over a WLAN that acts as a password when a mobile device tries to connect to the BSS. The SSID differentiates one WLAN from another, so all access points and all devices attempting to connect to a specific WLAN must use the same SSID. A device will not be permitted to join the BSS unless it can provide the unique SSID. Because the SSID is broadcast in plain text, it does not supply any security to the network.

Subnet mask

TCP-IP network is controlled by being divided into multiple smaller networks (subnets). IP address consists of the subnet address and the address of each computer. Subnet mask defines how many bits of IP address comprise the subnet address. The same value shall be set among computers communicating with each other.

TCP/IP (Transmission Control Protocol/Internet Protocol)

A standard protocol of the Internet.

Wi-Fi

Wi-Fi, or Wireless Fidelity, is a set of standards for wireless local area networks (WLAN) based on the IEEE 802.11 specifications. Certified products can use the official Wi-Fi logo, which indicates that the product is interoperable with any other product also showing that logo.

IP address information



IP addressing is much more complicated than can be briefly explained in this document. You are advised to consult with your network administrator for additional information.

If IP address is unknown, set IP address as follows:

If you have an access point (DHCP server) on the network, set the IP address as follows:

[Obtain an IP address automatically]



A DHCP server is a server that automatically assigns IP addresses to computers or other devices in the network. There is no DHCP server for the AdHoc network.

If the IP address is already assigned to the computer in the network, ask the network administrator to check the IP address to be set for the computer.

If no access point is found in the network:

An IP address is expressed with four values in the range between 1 and 255.

Set the each computer as follows: The value in parentheses is a subnet mask.

<Example>

Computer A: 192.168.100.2 (255.255.255.0)

Computer B: 192.168.100.3 (255.255.255.0)

Computer C: 192.168.100.4 (255.255.255.0)

:

:

Computer X: 192.168.100.254 (255.255.255.0)

Specifications

Item	Specification
Type of network	Conforms to IEEE 802.11a/802.11b/g (Wi-Fi based)*
Transfer rate	(Automatic switching) IEEE 802.11a/g: 54 Mbps maximum data rate IEEE 802.11b: 11 Mbps maximum data rate
Active frequency	802.11b/g: 2400~2473 MHz 802.11a: 4900 ~ 5850 MHz
Number of channels	802.11a: 8 independent channels 802.11b/g: 11 channels, 3 non-overlapping channels
Security	Encryption Types - WEP, TKIP, AES** WPA 1.0 compliant Encryption Keylengths Supported: 64 bits, 128 bits, and 152 bits (Using AES encryption only) 802.1x/EAP CCX 1.0 compliant
Maximum recommended number of computers to be connected over wireless LAN (during ad hoc connection)	10 units or less ***

* “Wi-Fi based” indicates that the interconnectivity test of the organization which guarantees the interconnectivity of wireless LAN (Wi-Fi Alliance) has been passed.

** Encryption with network key (WEP) is performed using the above number of bits, however, users can set 40 bits/104 bits after subtracting the fixed length of 24 bits.

*** Depending on practical environments, the allowable number of computers to be connected may be decreased.

Using the Bluetooth Device

The Integrated Bluetooth module (UGXZ5-102A) is an optional device available for Fujitsu mobile computers.

WHAT IS BLUETOOTH

Bluetooth technology is designed as a short-range wireless link between mobile devices, such as laptop computers, phones, printers, and cameras. Bluetooth technology is used to create Personal Area Networks (PANs) between devices in short-range of each other.

The Wireless LAN/Bluetooth On/Off Switch will power off both the optional wireless LAN and Bluetooth devices at the same time. To enable or disable either one of the devices individually, perform the following steps:



1. Slide the Wireless LAN/Bluetooth on/off switch to On position.
 2. In the Control Panel, double-click the Fujitsu Radio Control icon.
 3. In the window that appears, click the button associated with Bluetooth and/or Wireless LAN Status to enable or disable the individual devices.
 4. Click [OK].
-

WHERE TO FIND INFORMATION ABOUT BLUETOOTH

The Bluetooth module contains a robust Help user's guide to assist you in learning about operation of the Bluetooth device.

To access the Help file, click [Start] -> All Programs, and click on Toshiba. Select Bluetooth, then select User's Guide.

For additional information about Bluetooth Technology, visit the Bluetooth Web site at: www.bluetooth.com.

FCC Radiation Exposure Statement

This equipment complies with FCC radiation exposure limits set forth for an uncontrolled environment. The Bluetooth antenna is located on the right hinge of the LCD screen and is exempt from minimum distance criteria due to its low power.

The transmitters in this device must not be co-located or operated in conjunction with any other antenna or transmitter.

Canadian Notice

To prevent radio interference to the licensed service, this device is intended to be operated indoors and away from windows to provide maximum shielding. Equipment (or its transmit antenna) that is installed outdoors is subject to licensing.

Warranty

Users are not authorized to modify this product. Any modifications invalidate the warranty.

This equipment may not be modified, altered, or changed in any way without signed written permission from Fujitsu. Unauthorized modification will void the equipment authorization from the FCC and Industry Canada and the warranty.

Index

- A**
- About This Guide 1
 - AC
 - adapter 27
 - indicator 12
 - plug adapters 69
 - Anti-theft lock slot 10
 - Application Panel 20
 - Auto/Airline Adapter 27, 81
 - Automatically Downloading Driver Updates 65
- B**
- Battery 37
 - alarm 37
 - bay 11
 - care 70
 - charging indicator 13
 - cold-swapping 38
 - conserving power 32
 - dead 58
 - faulty 58
 - increasing life 70
 - level indicators 12
 - lithium ion battery 37, 83
 - low 37
 - problems 58
 - recharging 37
 - replacing 38
 - shorted 38
 - suspend mode 37
 - BIOS 81
 - guide 29
 - setup utility 29
 - Bluetooth
 - Where to Find Information 107
 - Boot Sequence 29
 - Built-in Speakers 54
- C**
- CapsLock 13
 - CD-ROM 39, 81
 - problems 54
 - Centrino 76
 - Clicking 16
 - Cold-swap 19, 38
 - COMM Port 81
 - Configuration Label 11, 75
 - Controls and Connectors 6
 - Conventions Used in the Guide 1
 - Cursor 16
 - Cursor Keys 14
- D**
- DC Power Jack 27
 - Default Value 82
 - Device Ports 48, 76
 - DIMM 46, 82
 - Disk care 70
 - Display Panel 6, 28
 - adjusting 28
 - brightness 28
 - closing 28
 - latch 6
 - opening 28
 - problems 59, 60
 - Display Timeout 33
 - Docking Port 49
 - Dolby Headphone 41
 - Double-Clicking 16
 - Dragging 17
 - Drivers and Application Restore CD 64
 - DVD drive
 - access indicator 13
 - tray release 63
 - DVD/CD-RW/CD-ROM
 - access indicator 13
 - problems 54
- E**
- ECP 82
 - Emergency tray release 10
 - Error Messages 62
 - ExpressCards 44
 - Extended Memory 82
 - External Floppy Disk Drive 42, 55
 - External Monitor Port 10, 50
- F**
- FDU 65, 78
 - Flexible Bay 8, 19
 - cold-swapping 19

devices	19	L	
eject lever	8	LAN (RJ-45) Jack	10
installing	19	LifeBook Security/Application Panel	6
Modular Multi-Format DVD Writer	39	buttons	22
removing	19	configuring	22
Floppy Disk		deactivating	23
ejecting	42	deactivating and activating	23
formatting	42	launching applications	22
initializing	42	operating	21
loading	42	passwords	20
preparing	42	uninstalling	21
write protect	42	M	
Fujitsu Contact Information	1	Media Player	
Fujitsu Driver Update utility	65, 78	care	71
Fujitsu LifeBook		Control Panel	40
storing	69	loading	39
traveling	69	removing	40
Function Key		Software	39, 40
F10	15	using	41
F3	15	Memory	
F4	15	capacity	46
F5	15	compartment	11, 46
F6	15	installing	46
F7	15	problems	56
F8	15, 18	removing	46
F9	15, 18	upgrade module	46
FN	15	Memory Stick	
H		installing	43
Hard Disk Drive		Microphone Jack	7, 50
access indicator	13	Modem	10
problems	55	problems	56
Hard Disk Timeout	33	Modem Jack	48
Headphone Jack	7, 50	Modem Result Codes	63
Hibernation Feature	32	Modular Devices	19
I		installing	19
IDE	83	removing	19
Infrared Port	49	Mouse	
Installing a Memory Stick	43	problems	55
Internal LAN Jack	48	MPU-401	84
IrDA	7, 49, 83	N	
K		Numeric Keypad	14
Keyboard	6, 14	NumLk	13
cursor keys	14	O	
function keys	14	Optical Digital Audio-Out Jack	7
numeric keypad	14	Optical Drive	39
problems	55		
windows keys	14		

- P**
- Parallel Port 48, 56, 84
 - PC Card
 - access indicator 13
 - care 71
 - problems 56, 57
 - removing 43
 - slot 9
 - Port Replicator
 - connector 11
 - problems 55
 - POST 84
 - Power
 - AC adapter 27
 - Auto/Airline adapter 27
 - failure 57
 - indicator 12
 - management 32
 - off 33
 - on 29
 - problems 58, 59
 - sources 27
 - Power Management 32, 33
 - Power On Self Test 29, 62
 - Power/Suspend/Resume Button 6, 32
 - Pre-Installed Software 78
 - Adobe Acrobat Reader 78
 - Fujitsu HotKey 78
 - Intel SpeedStep 78
 - LifeBook Application Panel 78
 - manuals 78
 - Quicken New User Edition 78
 - PS/2 Port 49
- R**
- Registration 30, 31
 - Removing a Memory Stick 43
 - Restoring Your Pre-installed Software 64
 - RJ-11 48
 - RJ-45 48
- S**
- ScrLk 13
 - SD Card, removing 43
 - SDRAM 11, 46
 - Secure Digital Card, removing 43
 - Security Indicator 13
 - Security Panel 20
 - Serial Port 49, 56, 85
 - Specifications 75
 - Audio 75
 - Chipset 75
 - Dimensions and Weight 77
 - Environmental Requirements 77
 - Keyboard 77
 - Memory 75
 - Microprocessor 75
 - Power 77
 - Video 75
 - Status Indicator Panel 6, 12
 - Stereo Speakers 6
 - Suspend 32, 85
 - S-Video 85
- T**
- Touchpad 6, 16
 - buttons 16
 - controls 17
 - Troubleshooting 53
- U**
- Universal Serial Bus Ports 49
 - Unpacking 5
 - USB 8, 10, 49, 56
- V**
- Volume control 18
- W**
- Warranty 1
 - WFM 86
 - Windows
 - Windows XP Home 1
 - Windows XP Professional 1
 - Windows keys 14
 - Application key 14
 - Start keys 14
 - Wireless LAN
 - Before Using the Wireless LAN 92
 - IP address information 105
 - Specifications 106
 - Troubleshooting 102
 - Wireless LAN Glossary 103

