

LIFEBOOK A532
LIFEBOOK AH532



Congratulations on your purchase of an innovative product from Fujitsu.

The latest information about our products, tips, updates etc. can be found on the Internet at: ["http://www.fujitsu.com/fts/"](http://www.fujitsu.com/fts/)

For automatic driver updates, go to: ["http://support.ts.fujitsu.com/download"](http://support.ts.fujitsu.com/download)

Should you have any technical questions, please contact:

- our Hotline/Service Desk (see the Service Desk list or visit: ["http://support.ts.fujitsu.com/contact/servicedesk"](http://support.ts.fujitsu.com/contact/servicedesk))
- Your sales partner
- Your sales office

We hope you enjoy working with your new Fujitsu system!



Published by

Fujitsu Technology Solutions GmbH
Mies-van-der-Rohe-Straße 8 (Mies-van-der-Rohe Street No. 8)
80807 Munich, Germany

Contact

<http://www.fujitsu.com/fts/>

Copyright

© Fujitsu Technology Solutions GmbH 2012. All rights reserved.

Publication Date

11/2012

Order No.: A26391-K343-Z320-2-7619, edition 1

LIFEBOOK A532

LIFEBOOK AH532

Operating Manual

Innovative technology	7
Ports and controls	9
Important notes	13
First-time setup of your device	16
Working with the notebook	19
Security functions	42
Connecting external devices	46
Removing and installing components during servicing	51
Settings in BIOS Setup Utility	59
Troubleshooting and tips	61
Technical data	68
Manufacturer's notes	70
Index	76

Remarks

Information on the product description meets the design specifications of Fujitsu and is provided for comparison purposes. Several factors may cause the actual results to differ. Technical data is subject to change without prior notification. Fujitsu rejects any responsibility with regard to technical or editorial mistakes or omissions.

Trademarks

Fujitsu, the Fujitsu logo and LIFEBOOK are registered trademarks of Fujitsu Limited or its subsidiaries in the United States and other countries.

Microsoft and Windows are trademarks or registered trademarks of the Microsoft Corporation in the United States and/or other countries.

Adobe Reader is a trademark of Adobe Systems Incorporated.

Sony and Memory Stick are registered trademarks of Sony Electronics, Inc.



Made under license from DTS Licensing Limited. DTS and the symbol are registered trademarks and & DTS Boost is a trademark of DTS, Inc. Product contains software. © DTS, Inc. All rights reserved.

All other trademarks specified here are the property of their respective owners.

Copyright

No part of this publication may be copied, reproduced or translated without the prior written consent of Fujitsu.

No part of this publication may be saved or transferred by any electronic means without the written approval of Fujitsu.

Contents

Innovative technology	7
Further information	7
Notational conventions	8
Ports and controls	9
Important notes	13
Safety notes	13
Additional safety notes for devices with radio components	13
Energy saving	14
Energy saving under Windows	14
Travelling with your notebook	14
Before you travel	14
Notebook: transporting	15
Cleaning the notebook	15
First-time setup of your device	16
Unpacking and checking the device	16
Selecting a location	17
Mains adapter connecting	17
Switching on the device for the first time	18
Working with the notebook	19
Status indicators	19
Switching on the notebook	21
Notebook: switching off	21
Keyboard	22
Separate number block	24
Key combinations	24
Country and keyboard settings	26
Touchpad and touchpad buttons	26
Moving the pointer	26
Selecting an item	27
Executing commands	27
Dragging items	27
Switching the Touchpad on and off	27
LCD screen	28
Webcam	29
Rechargeable battery	30
Charging, caring for and maintaining the battery	30
Removing and installing the battery	30
Optical drive	32
Handling data carriers	32
CD/DVD indicator	33
Inserting or removing a data carrier	33
Manual removal (emergency removal)	34
Using the power-management features	35
Memory cards	36
Supported formats	36
Inserting the memory card	36
Removing the memory card	36
ExpressCards	37

Inserting the card	37
Removing the card	38
Loudspeakers and microphones	38
SIM card (devices with UMTS module)	39
Inserting the SIM card	39
Removing the SIM card	39
Wireless LAN / Bluetooth / UMTS	40
Switching the wireless components on and off	40
Setting up WLAN access	40
Access via UMTS	40
Ethernet and LAN	41
Security functions	42
Using the Security Lock	42
Configuring password protection in BIOS Setup Utility	43
Protecting BIOS Setup Utility (supervisor and user password)	43
Password protection for booting of the operating system	44
Password protection for the hard disk	45
Connecting external devices	46
Connecting an external monitor	47
HDMI port	47
Connecting USB devices	48
USB port with charging function (Anytime USB charge)	49
How to remove USB devices correctly	49
Connecting external audio devices	50
Microphone port/Line In	50
Headphone port	50
Removing and installing components during servicing	51
Notes on installing and removing boards and components	51
Preparing to remove components	52
Installing and removing memory expansion	52
Removing the cover	53
Removing memory modules	53
Installing a memory module	54
Securing the cover	54
Removing and installing the hard disk	55
Removing a cover	55
Removing a hard disk	56
Installing a hard disk	57
Attaching the cover	58
Finishing component removal	58
Settings in BIOS Setup Utility	59
Starting the BIOS Setup Utility	59
Operating BIOS Setup Utility	59
Exiting BIOS Setup Utility	60
Exit Saving Changes - save changes and exit BIOS Setup Utility	60
Exit Discarding Changes – Discard changes and exit BIOS Setup Utility	60
Load Setup Defaults – Copy Standard Entries	60
Discard Changes – Discard changes without exiting the BIOS Setup Utility	60
Save Changes - save changes without exiting the BIOS Setup Utility	60
Save Changes and Power Off	60

Troubleshooting and tips	61
Help if problems occur	61
Restoring the hard disk contents under Windows	62
The notebook's date or time is incorrect	62
The notebook's LCD screen remains blank	62
The LCD screen is difficult to read	63
The external monitor remains blank	63
The external monitor is blank or the image is unstable	63
The notebook cannot be started	64
The notebook stops working	64
The printer does not print	65
The radio connection to a network does not work	65
Acoustic warnings	65
Error messages on the screen	65
Technical data	68
LIFEBOOK	68
Rechargeable battery	68
Mains adapter 80W	68
Power adapter, 65 W	69
Manufacturer's notes	70
Disposal and recycling	70
Declarations of Conformity	70
CE marking	70
Regulatory notices	70
Regulatory information for notebooks without radio device	71
DOC (Industry CANADA) notices	72
FCC regulatory information for notebooks with radio device	74
Index	76

Innovative technology

... and ergonomic design make your device a reliable and convenient companion.

The device boots very quickly, is ready for immediate use and offers a particularly long operating time because of its high capacity battery.

With the user-friendly "BIOS Setup Utility" you can control your notebook's hardware and better protect your system against unauthorised access by using the powerful password properties.



Information on the connections and user components of your notebook can be found in ["Ports and controls", Page 9.](#)

Further information









The Windows drivers for your device can be found on our Internet site. The factory installation of your device does not support any other operating system. Fujitsu Technology Solutions accepts no liability whatsoever if any other operating system is used.

Software oriented components of these instructions refer to Microsoft products, if they come within the scope of the delivery.

If you install other software products, pay attention to the operating instructions of the manufacturer.

Notational conventions

	Pay particular attention to text marked with this symbol. Failure to observe these warnings could pose a risk to health, damage the device or lead to loss of data. The warranty will be invalidated if the device becomes defective through failure to observe these warnings.
	Indicates important information for the proper use of the device.
	Indicates an activity that must be performed
	Indicates a result
This font	indicates data entered using the keyboard in a program dialogue or at the command line, e.g. your password (Name123) or a command used to start a program (start.exe)
This font	indicates information that is displayed on the screen by a program, e.g.: Installation is complete.
<i>This font</i>	Indicates <ul style="list-style-type: none"> • terms and texts used in a software interface, e.g.: Click on <i>Save</i> • names of programs or files, e.g. <i>Windows</i> or <i>setup.exe</i>.
"This font"	Indicates <ul style="list-style-type: none"> • cross-references to another section, e.g. "Safety information" • cross-references to an external source, e.g. a web address: For more information, go to "http://www.fujitsu.com/fts/" • Names of CDs, DVDs and titles or designations for other materials, e.g.: "CD/DVD Drivers & Utilities" or "Safety/Regulations" manual
	indicates a key on the keyboard, e.g: 
This font	indicates terms and texts that are emphasised or highlighted, e.g.: Do not switch off the device

Ports and controls

This chapter presents the individual hardware components of your device. It gives an overview of the indicators and connections of the device. Please familiarise yourself with these components before you start to work with the device.

Front

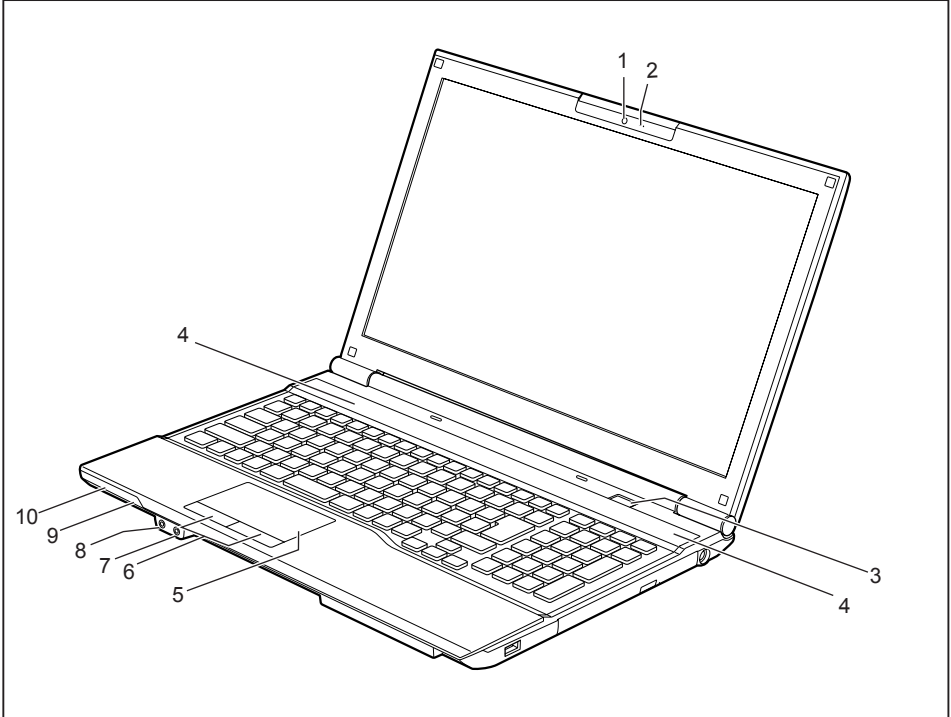

- 1 = Webcam
- 2 = WebCam LED
- 3 = ON/OFF switch
- 4 = Loudspeakers
- 5 = Touchpad

- 6 = Touchpad buttons
- 7 = Microphone jack
- 8 = Headphone port
- 9 = Memory card slot
- 10 = Status indicators

Left panel

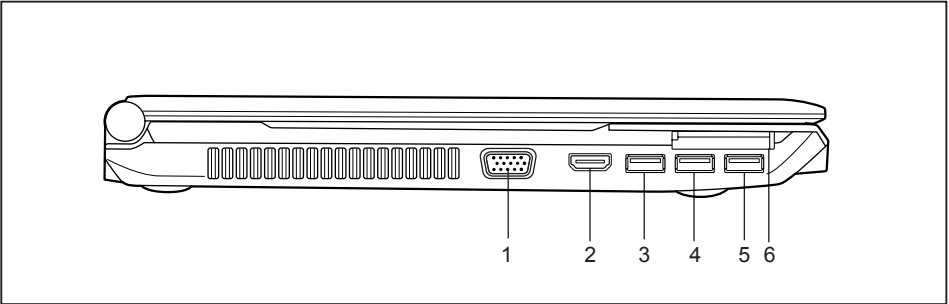

- 1 = VGA monitor port
- 2 = HDMI port
- 3 = USB port 3.0
- 4 = USB port 3.0

- 5 = USB port 3.0 with charging function
(Anytime USB charge)
- 6 = ExpressCard slot

Right-hand side

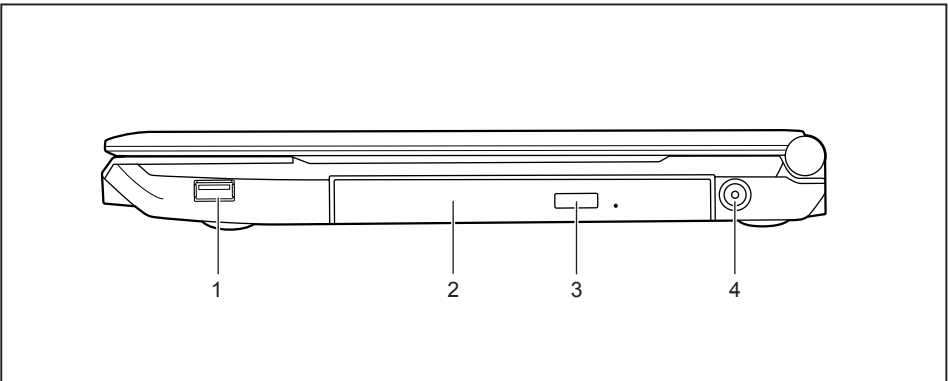

- 1 = USB port 2.0
- 2 = Optical drive

- 3 = Eject button for optical drive
- 4 = DC input connector (DC IN)

Rear

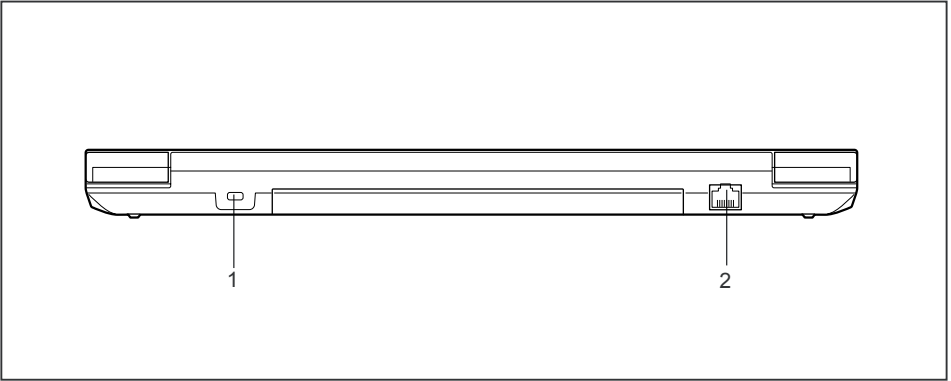

1 = Security Lock device

2 = LAN port

Underside

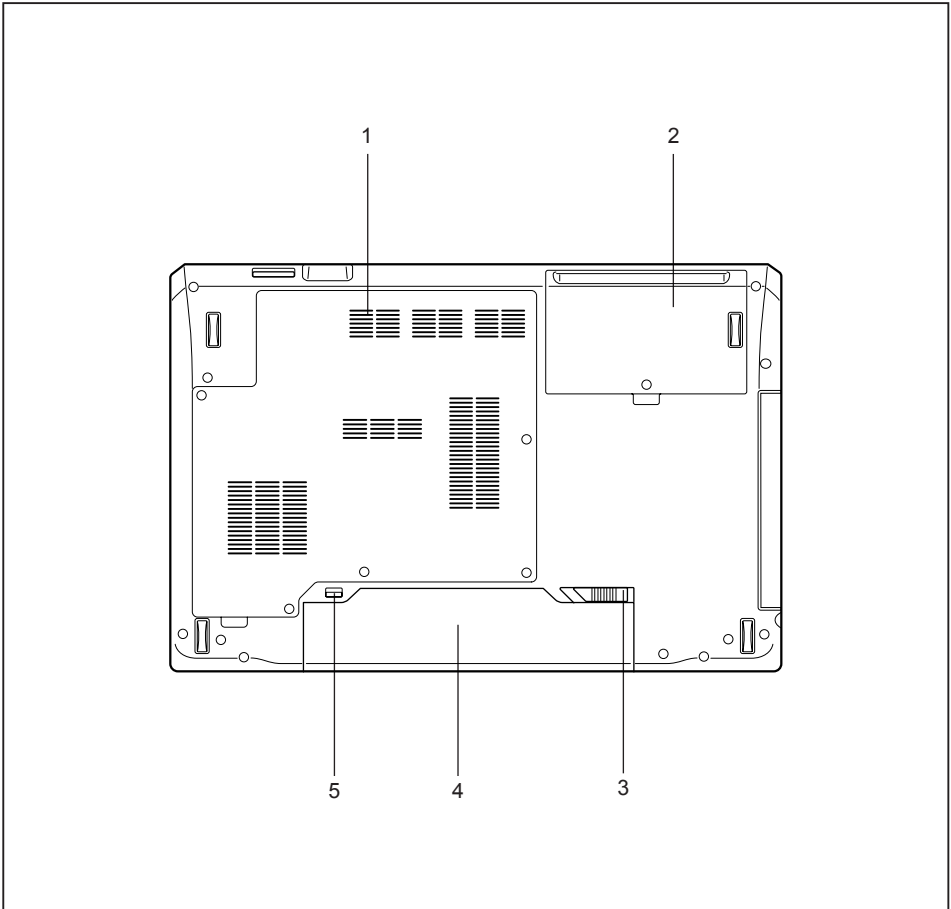

- 1 = Memory service compartment
- 2 = Hard disk service compartment
- 3 = Battery release

- 4 = Battery compartment with SIM card slot under battery (optional)
- 5 = Battery release

Important notes



This chapter contains essential safety information which must be followed when working with your notebook. Other notes also provide useful information which will help you with your notebook.

Safety notes



Please follow the safety notes provided in the "Safety/Regulations" manual as well as the safety notes given below.

Please pay special attention to the sections in the manual marked with the symbol on the left.

When connecting and disconnecting cables, observe the relevant notes in this operating manual.

Read the information on the ambient conditions in the ["Technical data", Page 68](#) and ["First-time setup of your device", Page 16](#) before preparing your notebook for use and switching it on for the first time.

When cleaning the device, please observe the relevant notes in the section ["Cleaning the notebook", Page 15](#).

Pay attention to the additional safety notes for devices with radio components provided in the "Safety/Regulations" manual.

Please refer to the notes in the chapter ["Removing and installing components during servicing", Page 51](#).

This notebook complies with the relevant safety regulations for data processing equipment. If you have questions about using your notebook in a particular area, please contact your sales outlet or our Hotline/Service Desk.

Additional safety notes for devices with radio components

If a radio component (Wireless LAN, Bluetooth, UMTS) is integrated in your notebook, you must be sure to observe the following safety notes when using your notebook:

- Switch off the radio components when you are in an aircraft or driving in a car.
- Switch off the radio components when you are in a hospital, an operating room or near a medical electronics system. The transmitted radio waves can impair the operation of medical devices.
- Switch off the radio components when you let the device get near flammable gases or into hazardous environments (e.g. petrol station, paintshops), as the transmitted radio waves can cause an explosion or a fire.



For information on how to switch radio components on and off, see chapter ["Switching the wireless components on and off", Page 40](#).

Energy saving

Switch the notebook off when it is not in use. Switch off external, connected devices if you are not using them. If you use the energy saving functions, the notebook uses less energy. You will then be able to work for longer before having to recharge the battery.



Energy efficiency is increased and the environmental impact is reduced. You save money while protecting the environment.

Energy saving under Windows

- ▶ Make use of the power management features (see ["Using the power-management features", Page 35](#)).

Travelling with your notebook

Please observe the points listed below when travelling with your notebook.

Before you travel

- ▶ Back up important data stored on your hard disk.
- ▶ Switch off the radio component for data security reasons. With data traffic via a wireless connection, it is also possible for unauthorised third parties to receive data.



Information on activating data encryption is provided in the documentation for your radio component.

- ▶ If you wish to use your notebook during a flight, first check with the flight attendants if it is OK to do so.

When travelling in other countries

- ▶ If you are travelling abroad, check that the mains adapter can be operated with the local mains voltage. If this is not the case, obtain the appropriate mains adapter for your notebook. Do not use any other voltage converter!
- ▶ Check whether the local mains voltage and the power cable are compatible. If this is not the case, buy a power cable that matches the local conditions.
- ▶ Enquire with the corresponding government office of the country you will be travelling in as to whether you may operate the radio component integrated in your notebook there (see also ["CE marking", Page 70](#)).

Notebook: transporting



Protect the notebook from severe shocks and extreme temperatures (e.g. direct sunlight in a car).

- ▶ If your device has an optical drive, remove all data media (e.g. CD, DVD) from the drives.
- ▶ Switch the notebook off.
- ▶ Unplug the mains adapter and all external devices from the power socket.
- ▶ Disconnect the mains adapter cable and the data cables for all external devices.
- ▶ Close the LCD screen.
- ▶ To protect against damaging jolts and bumps, use a notebook carrying case to transport your notebook.

Cleaning the notebook



Do not clean any interior parts yourself; leave this job to a service technician.

Only use cleaning products designed for computers. Normal household cleaners and polishes can damage the markings on the keyboard and the device, the paintwork or the notebook itself.

Ensure that no liquid enters the notebook.

The LCD screen very sensitive to scratches. Only clean the display surface with a very soft, slightly damp cloth.

- ▶ Switch the notebook off.
- ▶ In order to prevent accidentally switching the device on, remove the power cable from the mains adaptor and remove the battery (see ["Removing and installing the battery", Page 30](#)).
- ↳ The surface can be cleaned with a dry cloth. If particularly dirty, use a cloth which has been moistened in mild domestic detergent and then carefully wrung out.
To clean the keyboard and the touchpad, if available, you can use disinfectant wipes.
Ensure that no liquid enters the device.

First-time setup of your device



Please read the chapter ["Important notes", Page 13](#).

If your device is equipped with a Windows operating system, the necessary hardware drivers and supplied software are already pre-installed.

Before you switch on the device for the first time, connect it to the mains voltage using the mains adapter, see ["Mains adapter connecting", Page 17](#). The mains adapter must be connected during the entire installation process.

A system test is performed when your device is first switched on. Various messages can appear. The display may remain dark for a short time or may flicker.

Please follow the instructions on the screen.

NEVER switch off your device during the first-time setup process.

On delivery, the battery can be found in the battery compartment or in the accessories kit. The battery must be charged if you want to operate your device using the battery.

When used on the move, the built-in battery provides the device with the necessary power. You can increase the operating time by using the available energy-saving functions.

For instructions on how to connect external devices (e.g. mouse, printer) to your device, please refer to the operating manual for your device.

Unpacking and checking the device



Should you discover any damage that occurred during transportation, notify your local sales outlet immediately!

- ▶ Unpack all the individual parts.
- ▶ Check your device for any visible damage which may have occurred during transportation.



You may need the packaging in the future, if you need to transport your device.

Selecting a location



Select a suitable location for the device before setting it up. Follow the instructions below when doing so:

- Never place the device or the mains adapter on a heat-sensitive surface. The surface could be damaged as a result.
- Never place the device on a soft surface (e.g. carpeting, upholstered furniture, bed). This can block the air vents and cause overheating and damage.
- The underside of the device heats up during normal operation. Prolonged contact with the skin may become unpleasant or even result in burns.
- Place the device on a stable, flat, non-slippery surface. Please note that the rubber feet of the device may mark certain types of delicate surfaces.
- Keep other objects at least 100 mm away from the device and its mains adapter to ensure adequate ventilation.
- Never cover the ventilation slots of the device.
- Do not expose the device to extreme environmental conditions. Protect the device from dust, humidity, and heat.

Mains adapter connecting



Observe the safety notes in the enclosed "Safety/Regulations" manual.

The supplied power cable conforms to the requirements of the country in which you purchased your device. Make sure that the power cable is approved for use in the country in which you intend to use it.

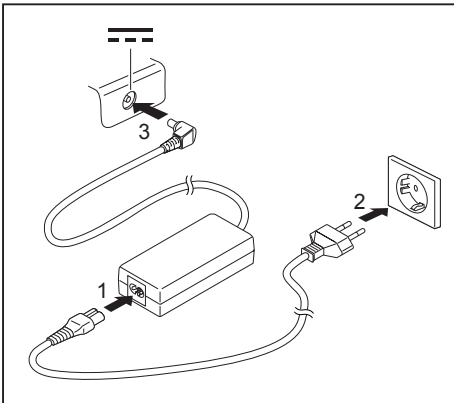

- ▶ Connect the power cable (1) to the mains adapter.
- ▶ Plug the mains cable (2) into a mains outlet.
- ▶ Connect the mains adapter cable (3) to the DC jack (DC IN) of the device.

Switching on the device for the first time



When you switch on the device for the first time, the supplied software is installed and configured. Because this procedure must not be interrupted, you should set aside enough time for it to be fully completed and connect the device to the mains using the mains adapter.

During the installation process, DO NOT restart the device unless you are requested to do so!

To make it easier to use your device for the first time, the operating system is pre-installed on the hard disk.

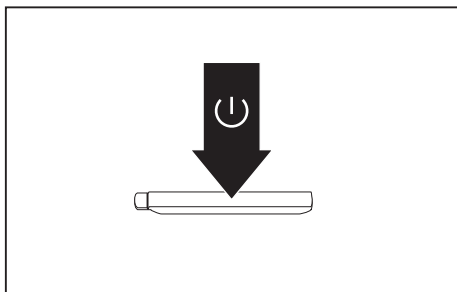

► Switch on your device.

► During installation, follow the instructions on screen.



If a Windows operating system is installed on your device, you will find more information on the system and drivers, help programmes, updates, manuals etc. on the device or on the Internet at ["http://www.fujitsu.com/fts/support/"](http://www.fujitsu.com/fts/support/).

You can find information and help on the Windows operating system functions on the Internet at ["http://windows.microsoft.com"](http://windows.microsoft.com).

Working with the notebook

This chapter describes the basics for operating your notebook. Please read the chapter entitled "[Connecting external devices](#)", [Page 46](#) for instructions on how to connect devices such as a mouse and a printer to the notebook.







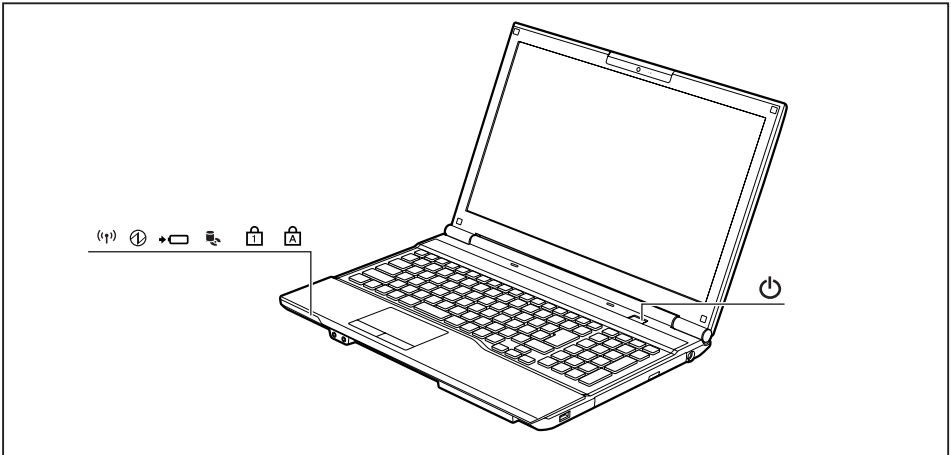

Please refer to the notes in "[Important notes](#)", [Page 13](#).

Status indicators

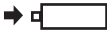
The status indicators provide information about the status of the power supply, the drives and the keyboard functions.



Status indicators	Description
	<p>Wireless components indicator</p> <ul style="list-style-type: none"> The indicator is lit: The wireless components are switched on. The indicator is not lit: The wireless components are switched off.
	<p>Power-on indicator/Standby</p> <ul style="list-style-type: none"> The indicator is lit: The notebook is switched on. The indicator flashes: The notebook is in standby mode. The indicator is not lit: The notebook is switched off.
	<p>Battery charging indicator/power connector</p> <p>The state of charge of the battery is shown by the battery indicator.</p> <p>Without the mains adapter connected:</p> <ul style="list-style-type: none"> Indicator is off: The system is in battery operation. The indicator flashes orange: The battery charge is less than 12%. <p>With mains adapter connected:</p> <ul style="list-style-type: none"> The indicator is illuminated (orange): The battery is charging. Indicator is blue: The battery is fully charged. Indicator flashes purple: a fault has occurred. The battery cannot be recharged. Indicator is off: There is no battery installed.
	<p>Drive indicator</p> <p>The indicator is lit: One of the drives (e.g. hard disk, CD/DVD) is being accessed.</p>
	<p>Num Lock indicator</p> <p>The indicator is lit: The <input type="text" value="Num"/> key has been pressed. The virtual numerical keypad is activated. You can output the characters indicated on the upper right of the keys.</p>
	<p>Caps Lock indicator</p> <p>The indicator is lit: The Caps Lock key has been pressed. All the characters you type will appear in upper case. In the case of overlay keys, the character printed on the upper left of the key will appear when that key is pressed.</p>

Switching on the notebook

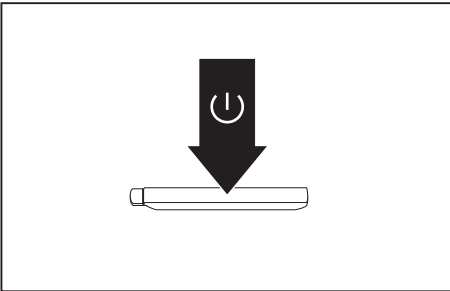

↳ The power-on indicator is lit.

- ▶ Open the LCD screen.
- ▶ Press the ON/OFF switch for about one second to switch the notebook on.

Notebook: switching off



Back up your data and close all applications before you switch off your device. Otherwise data might be lost.

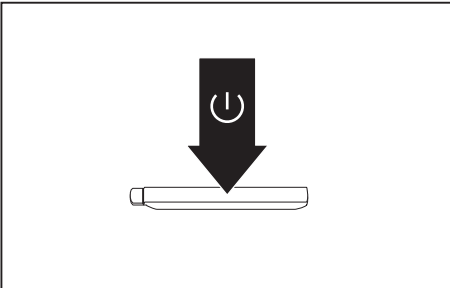

- ▶ Shut down the operating system correctly.
- ▶ If the notebook is not switched off automatically, press the ON/OFF switch for approx. five seconds.
- ▶ Close the LCD screen.

Keyboard



The keyboard of your notebook is subject to continuous wear through normal use. The key markings are especially prone to wear. The key markings are liable to wear away over the life of the notebook.

The keyboard has been designed to provide all the functions of an enhanced keyboard. Some enhanced keyboard functions are mapped with key combinations.







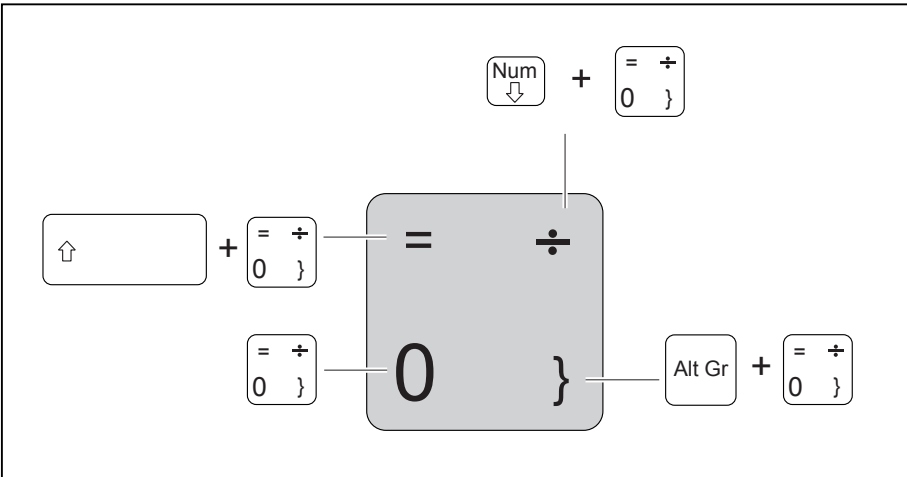

The following description of keys refers to Windows. Additional functions supported by the keys are described in the relevant manuals supplied with your application programs.

The figure below shows how to access the different characters on keys with overlaid functions. The example applies when the Caps Lock key has not been activated.



The illustrations shown below may differ from your actual device.

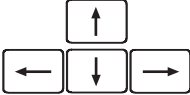

Key	Description
	Backspace key The Backspace key deletes the character to the left of the cursor.
	Tab key The Tab key moves the cursor to the next tab stop.
	Enter key (return) The Enter key terminates a command line. The command you have entered is executed when you press this key.
	Caps Lock key The Caps Lock key activates the Caps Lock mode, and the corresponding icon is displayed in the Windows information area. In Caps Lock mode, all of the characters you type appear in upper case. In the case of overlay keys, the character printed on the upper left of the key will appear when that key is pressed. To cancel the Caps Lock function, simply press the Caps Lock key again.
	Shift key The Shift key causes uppercase characters to appear. In the case of overlay keys, the character printed on the upper left of the key appears when that key is pressed.
	Fn button The [Fn] key enables the special functions indicated on overlay keys (see "Key combinations", Page 24).
	Cursor keys The cursor keys move the cursor in the direction of the arrow, i.e. up, down, left, or right.
	Windows key The Windows key switches between the start screen and the last used application.
	Menu key The Menu key opens the menu for the active application.

Separate number block

The keyboard of your notebook has a separate number block on the far right.

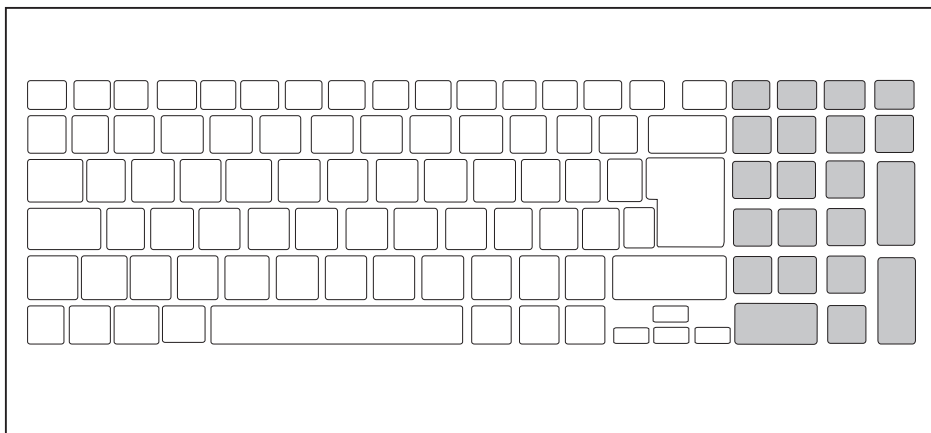







Key combinations





















The following description of key combinations applies to Windows operating systems. Some of the following key combinations may not function in other operating systems or with certain device drivers.

Other key combinations are described in the relevant manuals supplied with your application programs.

Key combinations are entered as follows:

- ▶ Press the first key in the combination and keep it pressed.
- ▶ While holding the first key down, press the other key or keys in the combination.

Combination	Description
 + 	<p>Switching the loudspeakers on and off This key combination switches your notebook's loudspeakers off and on.</p>
 + 	<p>Switching the touchpad and touchpad buttons on/off This key combination switches the touchpad and the touchpad buttons on or off.</p>
 + 	<p>Switching the wireless components on / off This key combination switches the wireless components off or on.</p>

Combination	Description
 + 	<p>Decrease screen brightness This key combination decreases the brightness of the screen.</p>
 + 	<p>Increase screen brightness This key combination increases the brightness of the screen.</p>
 + 	<p>Decrease volume This key combination reduces the volume of the internal loudspeakers.</p>
 + 	<p>Increase volume This key combination increases the volume of the internal loudspeakers.</p>
 + 	<p>Toggle output screen Use this key combination to select which screen(s) is/are used for display if an external monitor is connected.</p> <p>Screen output is possible:</p> <ul style="list-style-type: none"> • only on the notebook's LCD screen • on the LCD screen of the notebook and the external monitor at the same time • only on the external monitor <p>This setting is useful if you would like a high resolution and a high refresh rate on an external monitor.</p>
 + 	<p>Power management functions Use this key combination to activate the power management functions (see chapter "Using the power-management features", Page 35).</p>
 + 	<p>Switch webcam on/off This key combination switches the webcam on or off, provided the webcam has been enabled in the BIOS Setup utility.</p>
 + 	<p>Switch between open applications Use this key combination to switch between several open applications.</p>
 +  + 	<p>Windows security/Task-Manager This key combination opens the Windows security/Task-Manager window.</p>
 + 	<p>Back tab This key combination moves the cursor back to the previous tab stop.</p>



Key combinations using the Windows keys are detailed in the manual for your operating system.

Country and keyboard settings

- ▶ Change the country and keyboard settings as described in the documentation for your operating system.

Touchpad and touchpad buttons



Keep the touchpad clean. Protect it from dirt, liquids and grease.

Do not use the touchpad if your fingers are dirty.

Do not rest heavy objects (e.g. books) on the touchpad or the touchpad buttons.

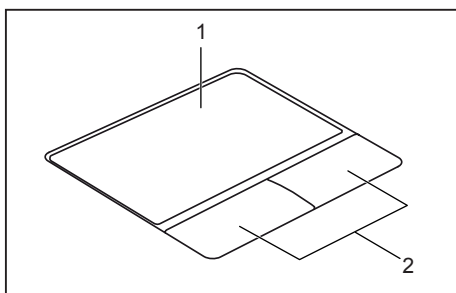

1 = Touchpad

2 = Touchpad buttons

The touchpad enables you to move the mouse pointer on the screen.

The touchpad buttons allow you to select and execute commands. They correspond to the buttons on a conventional mouse.



You can use a key combination to disable the touchpad, to avoid accidentally moving the pointer on the screen (see also ["Key combinations", Page 24](#)).

Moving the pointer

- ▶ Move your finger on the touchpad.
- ↳ The pointer will move.

Selecting an item

- ▶ Move the pointer to the item you wish to select.
- ▶ Tap the touchpad once or press the left button once.
- ↳ The item is selected.

Executing commands

- ▶ Move the pointer to the field you wish to select.
- ▶ Tap the touchpad twice or press the left button twice.
- ↳ The command is executed.

Dragging items

- ▶ Select the desired item.
- ▶ Press and hold the left button and drag the item to the desired position with the finger on the touchpad.
- ↳ The item will be moved.

Switching the Touchpad on and off



You can switch the Touchpad on and off using a key combination, see ["Key combinations", Page 24](#).

LCD screen

High-quality TFT displays are installed in notebooks from Fujitsu Technology Solutions GmbH. For technical reasons, TFT monitors are manufactured for a specific resolution. An optimal, clear picture can only be ensured with the correct resolution intended for the relevant TFT monitor. A monitor resolution which differs from the specification can result in an unclear picture.

The screen resolution of the LCD monitor of your notebook is optimally set at the factory.

The standard of production techniques today cannot guarantee an absolutely fault-free screen display. A few isolated constant lit or unlit pixels (picture elements) may be present. The maximum permitted number of pixels faults is stipulated in the international standard ISO 9241-3 (Class II).

Example:

A monitor with a resolution of 1280 x 800 has $1280 \times 800 = 1024000$ pixels. Each pixel consists of three subpixels (red, green and blue), so there are almost 3 million subpixels in total. According to ISO 9241-3 (class II), a maximum of 2 light and 2 dark pixels and an additional 5 light or 10 dark subpixels or a corresponding mix may be defective (1 light subpixel counts as 2 dark subpixels).

Pixel	A pixel consists of 3 subpixels, normally red, green and blue. A pixel is the smallest element that can be generated by complete functionality of the display.
Subpixel	A subpixel is a separately addressable internal structure within a pixel that enhances the pixel function.
Cluster	A cluster contains two or more defective pixels or subpixels in a 5 x 5 pixel block.

Background lighting

TFT monitors are operated with background lighting. The luminosity of the background lighting can decrease during the period of use of the notebook. However, you can set the brightness of your monitor individually.

Synchronising the display on the LCD screen and an external monitor

For more information, please refer to the chapter "[Key combinations](#)", [Page 24](#) under "Display output, switch between".

Webcam

Depending on the software used, you can use your Webcam to take pictures, record video clips or take part in web chats.

The WebCam has its own status indicator. The indicator lights up when the WebCam is switched on.

- The picture quality depends on the lighting conditions and the software being used.
- You can only operate the webcam with a particular application (e.g. an Internet telephony program or a video conferencing program which supports a webcam).
- When using the webcam the notebook support must not wobble.
- The webcam automatically adjusts itself to the current light level. For this reason the LCD screen may flicker while the light level is adjusted.



Further information on using the webcam and on the additional settings which are possible for your webcam can be found in the help function of the program which uses the webcam.

If you would like to perform a function test of your web cam, there is suitable test software available at ["http://www.fujitsu.com/fts/support/index.html"](http://www.fujitsu.com/fts/support/index.html).

Rechargeable battery

When not plugged into a mains socket, the notebook runs on its built-in battery. You can increase the life of the battery by caring for the battery properly. The average battery life is around 500 charge/discharge cycles.

You can extend the battery life by taking advantage of the available energy saving functions.

Charging, caring for and maintaining the battery

The notebook battery can only be charged, when the ambient temperature is between 5°C and max. 35°C.

You can charge the battery by connecting the notebook to the mains adapter (see ["Mains adapter connecting", Page 17](#)).

If the battery is running low you will hear a warning alarm. If you do not connect the mains adapter within five minutes of the warning alarm described above, your notebook will automatically switch off.

monitoring the battery charging level

Windows also has a "Battery status meter" in the taskbar for monitoring the battery capacity. When you place the mouse pointer on the battery symbol, the system displays the battery status.

Battery storage

Keep the battery pack between 0°C and +30°C. The lower the temperature at which the batteries are stored, the lower the rate of self-discharge.



If you will be storing batteries for a longer period (longer than two months), the battery charge level should be approx. 30 %. To prevent exhaustive discharge which would permanently damage the battery, check the level of charge of the battery at regular intervals.

To be able to make use of the optimal charging capacity of the batteries, the battery should be completely discharged and then fully recharged.



If you do not use the batteries for long periods, remove them from the notebook. Never store the batteries in the device.

Removing and installing the battery



Only use rechargeable batteries approved by Fujitsu Technology Solutions for your notebook.

Never use force when fitting or removing a battery.

Make sure that no foreign bodies get into the battery connections.

Never store a battery for longer periods in the discharged state. This can make it impossible to recharge.

Removing the battery

- ▶ Prepare for removal, see chapter ["Preparing to remove components", Page 52](#).

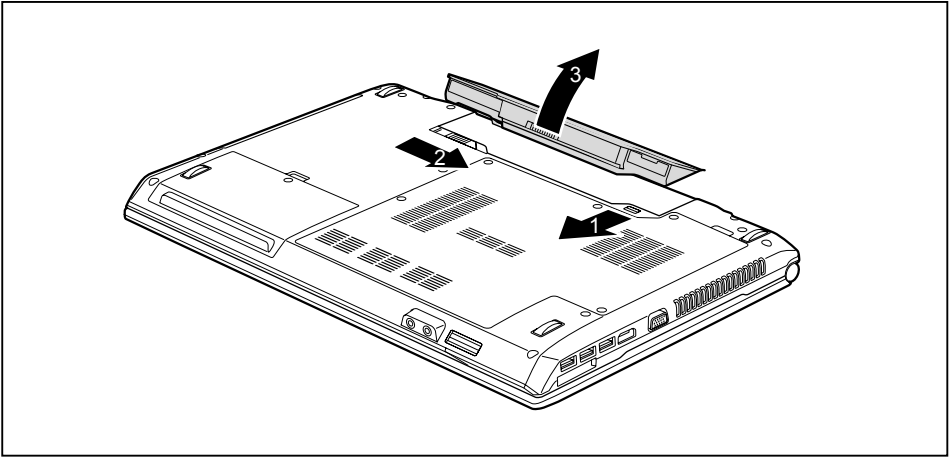

- ▶ Slide the release button in the direction of the arrow (1) and hold it in place.
- ▶ Slide the release button in direction of the arrow (2).
- ▶ Remove the battery from the battery compartment (3).

Inserting battery

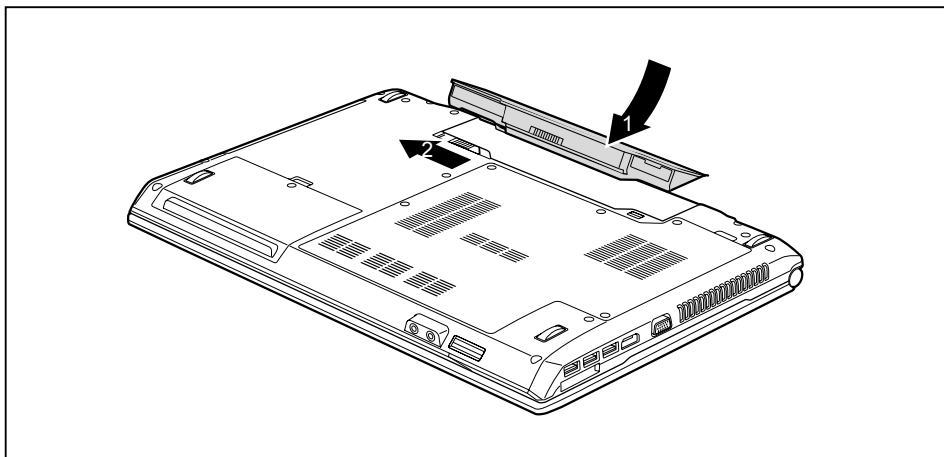

- ▶ Position the battery at the edge.
- ▶ Insert the battery into the battery compartment until it engages positively (1).
- ▶ Slide the release button in the direction of the arrow (2).
- ▶ Complete the removal, see chapter ["Finishing component removal", Page 58](#).

Optical drive



This product contains a light emitting diode, classification according to IEC 60825 1:2007: LASER CLASS 1, and must therefore not be opened.

Handling data carriers

Observe the following guidelines when handling data carriers:

- Avoid touching the surface of a data carrier. Only handle data carriers by their edges.
- Always store data carriers in their cases. This will protect the data carrier against being covered in dust, scratched or damaged in any other way.
- Protect your data carriers against dust, mechanical vibrations and direct sunlight.
- Avoid storing a data carrier in areas subject to high temperatures or humidity.

You may use both 8-cm and 12-cm data carriers in the optical drive.

When using a data carrier of lesser quality, vibrations and reading errors may occur.

CD/DVD indicator

The CD/DVD indicator flashes when a data carrier is inserted. The indicator goes out when the drive is ready for reading. The indicator lights up when the drive is being accessed. You may only remove the data carrier when the indicator is unlit.



If the CD/DVD indicator does not go out after a data carrier has been inserted, but instead continues to flash, this means that the drive cannot access the data carrier.

Either the data carrier is damaged or dirty or you are using a data carrier that the drive cannot read.

Inserting or removing a data carrier

The notebook must be switched on.

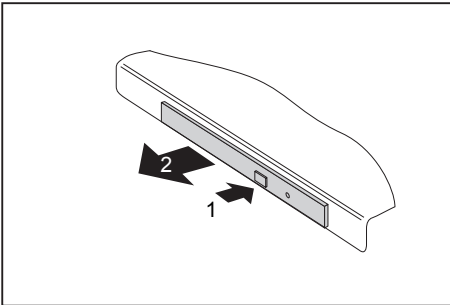

- ▶ Push the insert/eject button (1).
- ↳ The drive tray will open.
- ▶ Gently pull the drive tray (2) completely out.

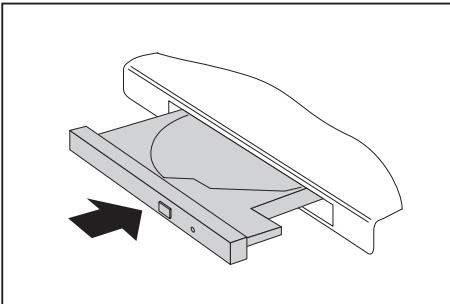

- ▶ Place the data carrier in the drive tray with the printed side facing upwards.

or

- ▶ Remove a data carrier that has been inserted.
- ▶ Push in the drive tray until you feel it lock into place.

Manual removal (emergency removal)

In the event of a power failure or damage to the drive, you can remove the data carrier manually.

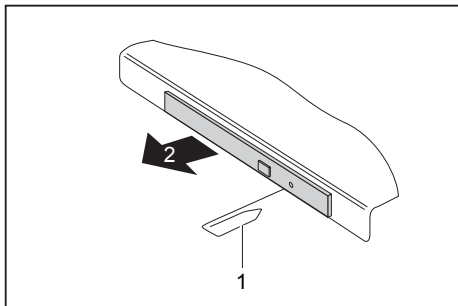

- ▶ Switch your notebook off.
- ▶ Push a pen or a piece of wire (such as a paperclip) firmly into the opening (1).
- ↳ The drive tray is ejected. You can now pull the drive tray (2) out of the drive.

Using the power-management features

The notebook uses less power when the available power-management features are used. You will then be able to work longer when using the battery before having to recharge it.



Power efficiency is increased and environmental pollution reduced. By choosing the best power options, you can make significant savings and at the same time help protect the environment.

When you close the LCD screen, depending on the setting in Windows, the notebook automatically enters a power saving mode.

We recommend the following settings:

Function	On external power	On battery power
Turn off monitor	After 10 minutes	After 5 minutes
Turn off hard disk(s)	After 15 minutes	After 10 minutes
Energy saving (S3)	After 20 minutes	After 15 minutes
Hibernate mode (S4)	After 1 hour	After 30 minutes

- ▶ Select the power management functions in your Control Panel.
- ▶ Select the Screen Saver in your Control Panel.



If you need further information about an option, you can get help with most settings by pressing **F1** to open the Microsoft Help.

When the notebook is in power-saving mode, the following must be remembered:



During power saving mode, open files are held in the main memory or in a swap file on the hard disk.

Never turn off your notebook while it is in a power saving mode. If the built-in battery is nearly empty, close the open files and do not go into power saving mode.

If you do not intend to use your notebook for a long period of time:

- ▶ Exit power saving mode if necessary via the mouse or keyboard or by switching on the notebook.
- ▶ Close all opened programs and completely shut down the notebook.

Memory cards

Your notebook is equipped with an integrated memory card reader.



Observe the manufacturer's instructions when handling the memory cards.

Supported formats

Your notebook supports the following formats:

- SDHC
- SDXC
- Memory Stick / Memory Stick pro (Sony®)

Inserting the memory card

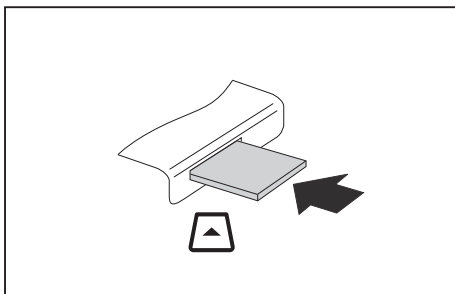

- ▶ Carefully slide the memory card into the slot. The label should be facing upward. Do not apply excessive force, as otherwise the delicate contact surfaces could be damaged.
- ↳ Depending on the particular type used, the memory card may protrude slightly from the slot.

Removing the memory card



To avoid any loss of data, always follow the correct procedure for removing the card (see the documentation for your operating system).

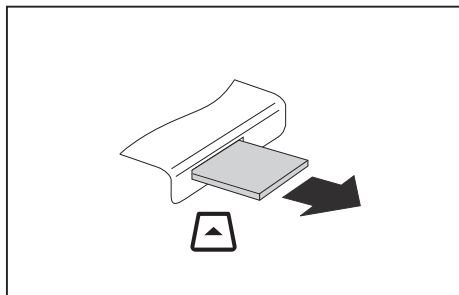

- ▶ Pull the memory card out of the slot.

ExpressCards

An ExpressCard slot allows an ExpressCard/34 to be used with the computer.



Consult the documentation supplied by the ExpressCard's manufacturer and follow the instructions provided.

Never use force when installing or removing an ExpressCard.

Make sure that no foreign objects enter the ExpressCard slot.

Inserting the card



Keep the placeholder for the slot in a safe place. When you remove the card again, you must reinstall the place holder. This prevents foreign objects from getting into the slot.

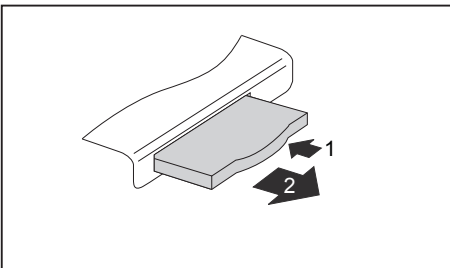

- ▶ Press the edge of the placeholder (1) to make the card placeholder protrude from the notebook's case.
- ▶ Pull the card placeholder out of the slot (2).

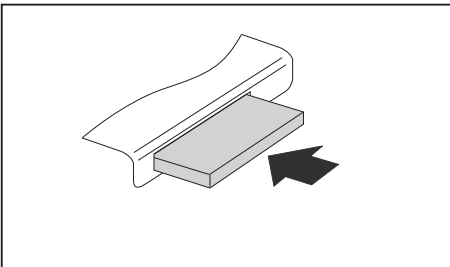

- ▶ Insert the card into the slot guide with the connection contacts first.
- ▶ Gently push the card into the slot until you feel it click into place. Do not use any force. Depending on the particular type used, the card may protrude slightly from the slot.



Please see the documentation relating to the card for driver installation instructions.

Removing the card



To avoid any loss of data, always follow the correct procedure for removing the card (see the documentation for your operating system).

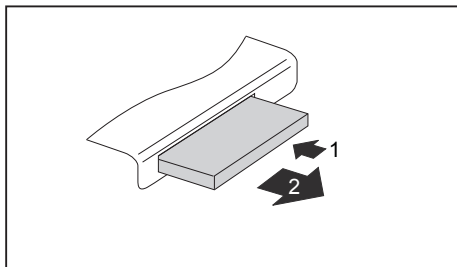

- ▶ Press the edge of the card (1) so that the card protrudes a little from the notebook.
- ▶ Pull the card out of the slot (2).

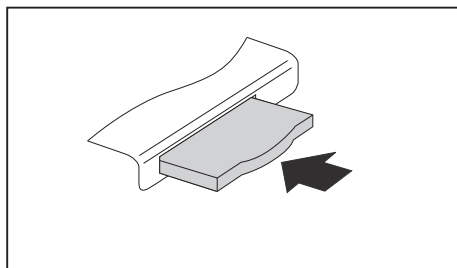

- ▶ Insert the card placeholder into the slot guide.
- ▶ Gently slide the card placeholder into the slot until you feel it click into place.

Loudspeakers and microphones

Information on the exact position of the speakers and microphone can be found in ["Ports and controls", Page 9](#).

Please refer to chapter ["Key combinations", Page 24](#) for information on setting the volume and also enabling/disabling the loudspeakers using key combinations.



If you attach an external microphone, the built-in microphone is disabled.

The internal microphone can be deactivated together with the WebCam via the key combination **[Fn] + [F12]**. In addition, the internal microphone can be deactivated together with the WebCam in the BIOS Setup Utility.

When you connect headphones or external speakers, the built-in speakers are disabled.

Information on connecting headphones and a microphone can be found in ["Connecting external devices", Page 46](#).

SIM card (devices with UMTS module)

A SIM Card (Subscriber Identity Module) is a chip card which is inserted in a mobile telephone or notebook to enable access to a mobile radio network in conjunction with an installed UMTS module.



Follow the instructions supplied by the provider of the SIM card.

The SIM card slot is located in the battery compartment and can only be accessed when the battery is removed.

Inserting the SIM card

- ▶ Prepare for installation of the SIM card, see chapter ["Preparing to remove components", Page 52.](#)

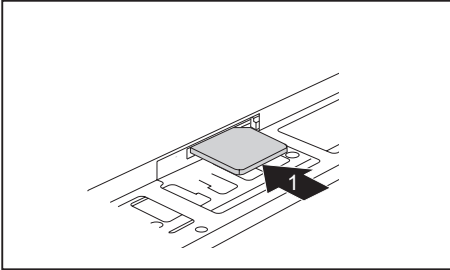

- ▶ Slide the SIM card into the slot (1) until it is felt to engage, as shown in the battery compartment.

- ▶ Complete the installation, see chapter ["Finishing component removal", Page 58.](#)

Removing the SIM card

- ▶ Prepare for removal of the SIM card, see chapter ["Preparing to remove components", Page 52.](#)

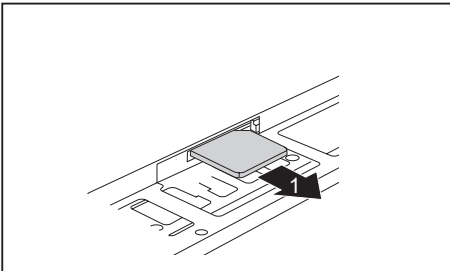

- ▶ Press on the edge of the SIM card so that it jumps up slightly out of the slot.
- ▶ Pull the SIM card out of the slot in the direction of the arrow (1).

- ▶ Complete the removal, see chapter ["Finishing component removal", Page 58.](#)

Wireless LAN / Bluetooth / UMTS



The installation of radio components not approved by Fujitsu Technology Solutions will invalidate the certifications issued for this device.

Switching the wireless components on and off

- ▶ Press the key combination **[Fn] + [F5]** to start the *WirelessSelector*.
- ↳ The wireless component indicator will illuminate when one or more wireless components are switched on.



The Bluetooth and UMTS modules and the wireless LAN transmission unit (antenna) will also be switched off when you switch off the wireless components.

Pay attention to the additional safety notes for devices with wireless components provided in the "Safety" manual.

Details on using a Wireless LAN can be found in the online help system included in the Wireless LAN software.

You can obtain more information on UMTS from your service provider.

Setting up WLAN access

- Requirement: A WLAN must be available and you must have the corresponding access information.



Information on configuring the WLAN access can be found in the documentation for your operating system.

Access via UMTS

If you have ordered an integrated UMTS module with your system, you can enjoy the best reception and maximum energy efficiency, without any disruptive cables or aerials. The optional UMTS module is ready for use immediately.

If you have not ordered a UMTS module, you can purchase the accessories for UMTS reception from specialised dealers or from your Fujitsu Technology Solutions dealer.

You will find information on establishing the connection with the UMTS network in the documentation for the hardware used.

Your device can connect with the Internet via UMTS. To do this, use one of the following types of connection:

- an integrated UMTS module (depending on your model variant)
- a USB dongle (a USB stick with your mobile phone provider's SIM card)
- a UMTS ExpressCard (to be inserted in the ExpressCard slot of your device)
- a mobile end-device (e.g. mobile phone with Bluetooth or cable connection)

Ethernet and LAN

The internal network module of your notebook supports Ethernet LAN. You can use it to establish a connection to a local network (LAN = Local Area Network).

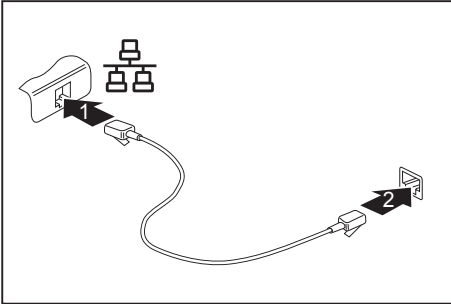

- ▶ Connect the network cable to the LAN port of the notebook (1).
- ▶ Connect the network cable to your network connection (2).

i

Your network administrator can help you to configure and use the LAN connections.

The network cable is not included in the delivery scope. This type of cable can be obtained from a specialist dealer.

Security functions

Your notebook has several security features that you can use to secure your system from unauthorised access.

This chapter explains how to use each function, and what the benefits are.



Please remember that in some cases, for example, forgetting your password, you may be locked out and unable to access your data. Therefore, please note the following information:

- Make regular backups to external data carriers such as external hard drives, CDs, DVDs or Blu-ray Discs.
- Some security functions need you to choose passwords. Make a note of the passwords and keep them in a safe place.

If you forget your passwords you will need to contact our Service Desk. Deletion or resetting of passwords is not covered by your warranty and a charge will be made for assistance.

Using the Security Lock

Your device comes with a Security Lock mechanism for the Kensington Lock Cable. You can use the Kensington Lock Cable, a sturdy steel cable, to help protect your notebook from theft. The Kensington Lock Cable is available as an accessory.



Fujitsu Technology Solutions recommends the use of a combination lock.

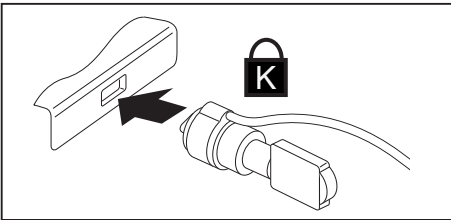

- ▶ Fit the Kensington Lock Cable to the mechanism on your notebook.

Configuring password protection in BIOS Setup Utility



Before using the various options for password protection in the *BIOS Setup utility* to increase data security, please observe the following:

Make a note of the passwords and keep them in a safe place. If you forget your supervisor password you will not be able to access your notebook. Passwords are not covered by your warranty and a charge will be made for assistance.



Your password can be up to eight characters long and contain letters and numbers. No distinction is made between uppercase and lowercase.

Protecting BIOS Setup Utility (supervisor and user password)



If you have opened these operating instructions on the screen, we recommend that you print them out. You cannot call the instructions onto the screen while you are setting up the password.

The supervisor password and the user password both prevent unauthorised use of the *BIOS-Setup-Utility*. With the aid of the supervisor password you can access all of the functions of the *BIOS-Setup-Utility*, while the user password will only give you access to some of the functions. You can only set up a user password if a supervisor password has already been assigned.



Please refer to section "[Settings in BIOS Setup Utility](#)", [Page 59](#) for a description of how to call up and operate the *BIOS-Setup-Utility*.

Setting supervisor and user password

- ▶ Start the *BIOS Setup Utility* and go to the *Security* menu.
- ▶ Select the *Set Supervisor Password* field and press the Enter key.
- ↳ With *Enter new Password*: you are asked to enter a password.
- ▶ Enter the password and press the Enter key.
- ↳ *Confirm new Password* requires you to confirm the password.
- ▶ Enter the password again and press the Enter key.
- ↳ *Changes have been saved* is a confirmation that the new password has been saved.
- ▶ To set the user password, select *Set User Password* and proceed exactly as when configuring the supervisor password.
- ↳ If you do not want to change any other settings, you can exit *BIOS Setup Utility*.
- ▶ In the *Exit* menu, select the option *Save Changes & Exit*.
- ▶ Select *Yes* and press the Enter key.
- ↳ The notebook will be rebooted and the new password will come into effect. It will now be necessary to first enter your supervisor or user password in order to open the *BIOS Setup Utility*. Please note that the user password only provides access to a few of the BIOS settings.

Changing the supervisor or user password

You can only change the supervisor password when you have logged into the *BIOS Setup Utility* with the supervisor password.

- ▶ Call the *BIOS Setup Utility* and go to the *Security* menu.
- ▶ When changing the password, proceed exactly as for password assignment.

Removing passwords

To remove a password (without setting a new password) perform the following steps:

- ▶ Start the *BIOS Setup Utility* and go to the *Security* menu.
- ▶ Highlight the *Set Supervisor Password* or *Set User Password* field and press the Enter key.
 - ↳ You will be requested to enter the current password by the *Enter Current Password* prompt. You will be requested to enter a new password by the *Enter New Password* prompt.
- ▶ Press the Enter key twice.
- ▶ In the *Exit* menu, select the option *Save Changes & Exit*.
- ▶ Select *Yes* and press the Enter key.
 - ↳ The notebook will now reboot with the password removed. Removing the supervisor password simultaneously deactivates the user password.

Password protection for booting of the operating system



With the supervisor password you have set in the *BIOS Setup Utility* (see section ["Setting supervisor and user password", Page 43](#)), you can also prevent booting of the operating system.

Activating system protection

- ▶ Start the *BIOS Setup Utility* and go to the *Security* menu.
- ▶ Select the *Password on Boot* option and press the Enter key.
- ▶ Select the desired option (*Disabled*, *First Boot* or *Every Boot*) and press the Enter key.
- ▶ Select the *Save Changes & Exit* option under *Exit*.
 - ↳ The notebook will reboot. You will be prompted to enter your password (the supervisor password).

Deactivating system protection

- ▶ Start the *BIOS Setup Utility* and go to the *Security* menu.
- ▶ Select the *Password on Boot* option and press the Enter key.
- ▶ Select the *Disabled* option and press the Enter key.
 - ↳ If you do not want to change any other settings, you can exit *BIOS Setup Utility*.
- ▶ Select the *Save Changes & Exit* option under *Exit*.
 - ↳ The notebook will reboot. The system is no longer password-protected.

Password protection for the hard disk



The hard disk password prevents unauthorised access to the hard disk drives and is checked internally each time the system is booted. The condition for this is that you have assigned at least the supervisor password.

Activating hard disk protection

- ▶ Call up the *BIOS Setup* and select the *Security* menu.
- ↳ If you have not assigned BIOS passwords yet, define the supervisor and the user password now, if desired (see "[Security functions](#)", [Page 42](#)).
- ▶ Mark the *Hard Disk Security* field and press the Enter key.
- ▶ In the *Drive0* area mark the *Set Master Password* field and press the Enter key.
- ↳ *Enter new Password* then appears and you are asked to enter a password.
- ▶ Enter the password and press the Enter key.
- ↳ *Confirm new Password* requires you to confirm the password.
- ▶ Enter the password again and press the Enter key.
- ↳ *Setup Notice: Changes have been saved* is displayed to confirm that the new password has been saved.
- ▶ To assign the password for the second hard disk (*Drive1*), go to the *Drive1* area and select the field *Set Master Password*, then proceed in exactly the same way as for setting up the password for the first hard disk (*Drive0*).
- ↳ The field *Password Entry on Boot* is set to *Enabled* by default. You can exit the *BIOS Setup* once you have finished changing the settings.
- ▶ From the *Exit* menu, choose the option *Exit Saving Changes*.
- ▶ Press the Enter key and select *Yes*.
- ↳ The notebook reboots and your hard disk is now protected with a password. The system will ask you to enter the password when the notebook is restarted again.

Deactivating hard disk protection

To cancel a password without setting a new one, proceed as follows:

- ▶ Call up the *BIOS Setup* and select the *Security* menu.
- ▶ Mark the *Hard Disk Security* field and press the Enter key.
- ▶ In the *Drive0* area mark the *Set Master Password* field and press the Enter key.
- ↳ You will be initially requested to enter the old password by the *Enter current Password* prompt. You will then be requested to enter a new password by the *Enter new Password* prompt.
- ▶ After entering the password, press the Enter key three times.
- ▶ From the *Exit* menu, choose the option *Exit Saving Changes*.
- ▶ Press the Enter key and select *Yes*.
- ↳ The notebook reboots, and password protection for the hard disk is cancelled.
- ▶ To cancel the password for the second hard disk (*Drive1*), go to the *Drive1* area and select the field *Set Master Password*, then proceed in exactly the same way as for cancelling the password for the first hard disk (*Drive0*).

Connecting external devices



Always refer to the safety information provided in "[Important notes](#)", [Page 13](#) before connecting or disconnecting any devices to or from your notebook.

Always read the documentation supplied with the device you wish to connect.

Never connect or disconnect cables during a thunderstorm.

Never pull at a cable when disconnecting it. Always grasp the plug.

Follow the steps below in order, when connecting or disconnecting devices to your notebook:



With some devices such as USB devices, it is not necessary to switch off the notebook and the device before connecting/disconnecting. For more information about whether or not devices need to be switched off, please refer to the documentation supplied with the external device.

Some of the external devices require special drivers (see the operating system and external device documentation).

Connecting devices to the notebook

1. Turn off your notebook and all external devices.
2. Unplug your notebook and all devices from the mains sockets.
3. Connect the cables for your external devices following the instructions.
4. Plug all power cables into the mains sockets.

Disconnecting devices from the notebook

1. Turn off your notebook and all external devices.
2. Unplug your notebook and all devices from the mains sockets.
3. Disconnect the cables for your external devices following the instructions.

Connecting an external monitor

You can connect an external monitor to the analogue VGA monitor connection of the notebook. Screen output is limited to a maximum of two screens at any one time (see ["Key combinations"](#), [Page 24](#), section "Toggle output screen").

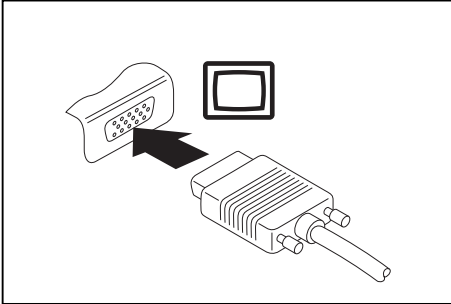

Analogue VGA monitor connection socket

- ▶ Switch off the notebook and the external monitor.
- ▶ Connect the data cable of the external monitor to the monitor port of the notebook.
- ▶ First switch on the external monitor and then the notebook.

i

You can also use a key combination to switch back and forth between the external monitor and the notebook's LCD screen, see chapter ["Key combinations"](#), [Page 24](#).

You can display the same picture on the external monitor and the notebook LCD screen simultaneously.

HDMI port

The HDMI port on your notebook can be used to connect an external amplifier, LCD TV or a plasma TV with an HDMI connection.

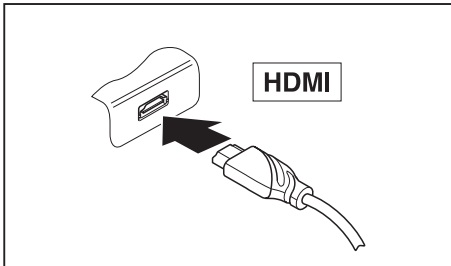

- ▶ Connect the data cable to the external device.
- ▶ Connect the data cable to the HDMI port of the notebook.

Connecting USB devices

On the USB ports, you can connect external devices that also have a USB port (e.g. a DVD drive, a printer, a scanner or a modem).



USB devices are hot-pluggable. This means you can connect and disconnect devices while your operating system is running.

USB 1.x has a maximum data transfer rate of 12 Mbit/s.

USB 2.0 has a data transfer rate of up to 480 Mbit/s.

USB 3.0 has a data transfer rate of up to 5 Gbit/s.

Additional information can be found in the documentation for the USB devices.

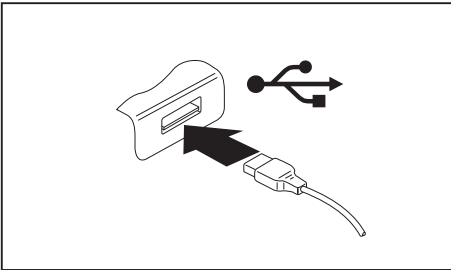

- ▶ Connect the data cable to the external device.
- ▶ Connect the data cable to a USB port of the notebook.



Device drivers

USB devices will be automatically recognised and installed by your operating system.

USB port with charging function (Anytime USB charge)



It is recommended that the notebook be operated with the power supply connected whenever the USB port with charging function is in use, as this function will drain the battery more quickly if an external USB device is being charged.

The power supply unit must already be connected when the notebook is switched off, as otherwise the USB charging function will be disabled and the connected USB devices will not be charged.



Some USB devices (e.g. mobile telephones) require a driver in order to utilise the USB charging function. In this case the USB charging function will not work when the notebook is switched off, as no drivers are active when the notebook is switched off.

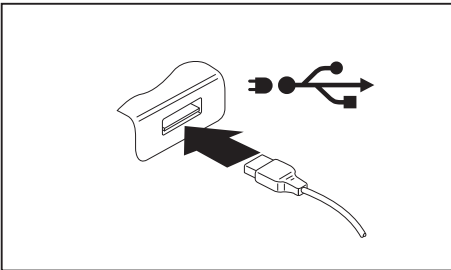

You can use this USB port to charge or supply power to a USB device (e.g. to charge a PDA or a mobile phone or to connect a USB lamp), even if the notebook is switched off.

How to remove USB devices correctly



Always correctly remove the device according to the rules described below, to ensure that none of your data is lost.

- ▶ Left click on the icon to safely remove hardware, located in the taskbar.
- ▶ Select the device which you want to shut down and remove.
- ▶ Press the Enter key.
- ↳ Wait for the dialogue box which tells you that it is now safe to remove the device.

Connecting external audio devices

Microphone port/Line In

The microphone port/Line In allows you to connect an external microphone, a MiniDisc player, MP3 player, CD player or a tape deck to your notebook.

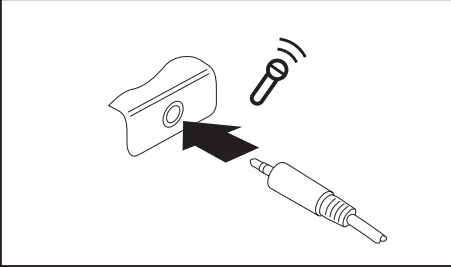

- ▶ Connect the audio cable to the external device.
- ▶ Connect the audio cable to the microphone port/Line In of the notebook.

Headphone port

You can connect headphones or external loudspeakers to your notebook via the headphone port.

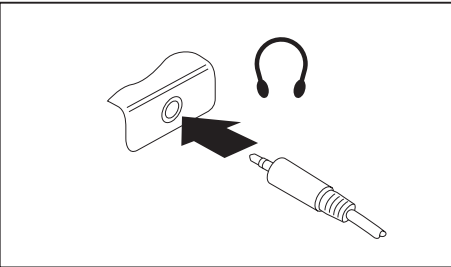

- ▶ Connect the audio cable to the external device.
- ▶ Connect the audio cable to the headphone port of the notebook.
- ↳ The internal loudspeakers are disabled.



If you purchase a cable from a retailer, please note the following information:

The headphone port on your notebook is a "3.5 mm jack socket".

If you want to connect headphones or a speaker you will need a "3.5 mm jack plug".

Removing and installing components during servicing



Only qualified technicians should repair your notebook. Unauthorised opening or incorrect repair may greatly endanger the user (electric shock, fire risk) and will invalidate your warranty.

After consulting the Hotline/Service Desk, you may remove and install the components described in this chapter yourself.



If you remove and install components without consulting the Hotline/Service Desk, then the warranty of your notebook will be voided.

Notes on installing and removing boards and components

- Switch the notebook off and pull the power plug out of the mains socket.
- Always remove the battery.
- Take care when you use the locking mechanisms on the battery and any other component.
- Never use sharp objects such as screwdrivers, scissors or knives as leverage to remove covers.



Boards with electrostatic sensitive devices (ESD) are marked with the label shown.

When handling boards fitted with ESDs, you must always observe the following points:

- You must always discharge static build up (e.g. by touching a grounded object) before working.
- The equipment and tools you use must be free of static charges.
- Remove the power plug from the mains supply before inserting or removing boards containing ESDs.
- Always hold boards with ESDs by their edges.
- Never touch pins or conductors on boards fitted with ESDs.

Preparing to remove components

If you are going to remove or change system components, prepare for the removal as follows:



Please observe the safety information in chapter ["Important notes", Page 13](#).

Remove the power plug from the mains outlet !

- ▶ Switch the device off.



The device must not be in energy-saving mode !

- ▶ Close the LCD screen.
- ▶ Remove all the cables from the device.
- ▶ Turn the device over and place it on a stable, flat and clean surface. If necessary, lay an anti-slip cloth on this surface to prevent the device from being scratched.
- ▶ Remove the battery (see ["Removing the battery", Page 31](#)).

Installing and removing memory expansion

If you are asked by the Hotline/Service Desk to remove and install the memory expansion yourself, proceed as follows:



Please observe the safety information in chapter ["Important notes", Page 13](#).

When installing/removing memory modules, the battery must be removed from the notebook and the notebook must not be connected to the power supply, see ["Preparing to remove components", Page 52](#).

Only use memory expansion modules that have been approved for your notebook (see ["Technical data", Page 68](#)).

Never use force when installing or removing a memory extension.

Make sure that foreign objects do not fall into the memory extension compartment.

You must open the service compartment to remove or install a memory module. On some devices, opening the compartment may expose other components. These components should be removed and replaced only by authorised specialists. Therefore, be sure to observe the following:



Individual components can become very hot during operation. Therefore, we recommend that you wait one hour after switching off the notebook before removing or installing memory modules. Otherwise, there is a risk of suffering burns!

As some components are exposed that are sensitive to static electricity, please take note of chapter ["Notes on installing and removing boards and components", Page 51](#).

Removing the cover

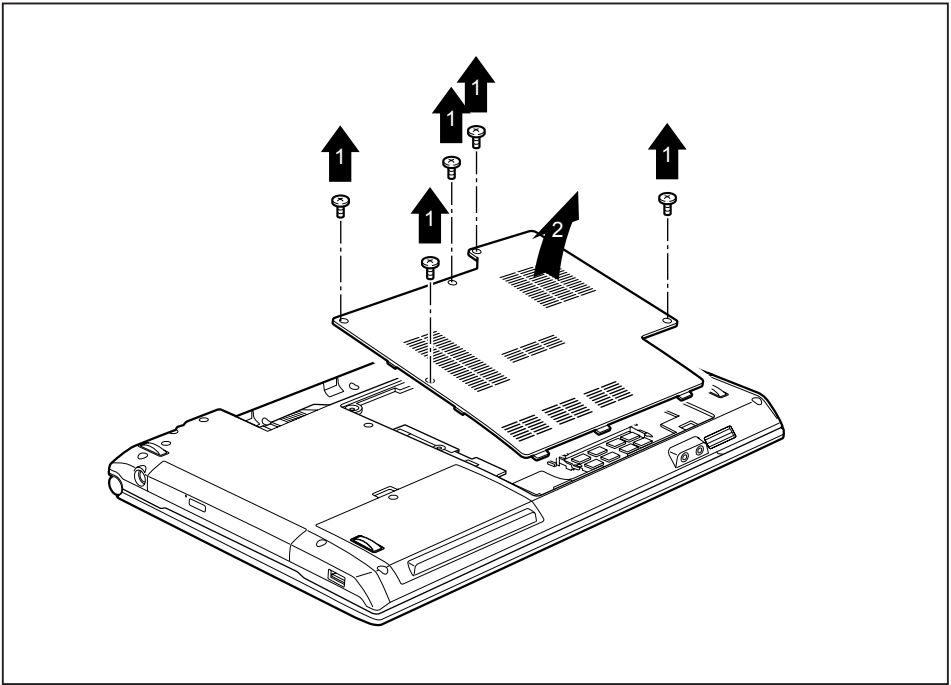

- ▶ Remove the screws (1).
- ▶ Lift the cover off the notebook (2).

Removing memory modules

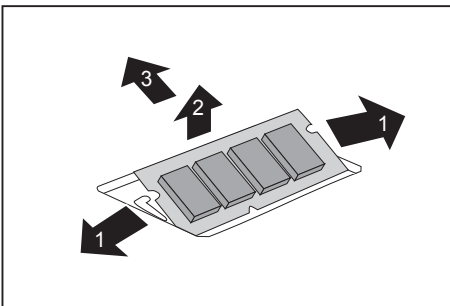

- ▶ Carefully push the two mounting clips outwards (1).
- ↳ The memory module snaps upwards (2).
- ▶ Pull the memory module out of its slot in the direction of the arrow (3).

Installing a memory module

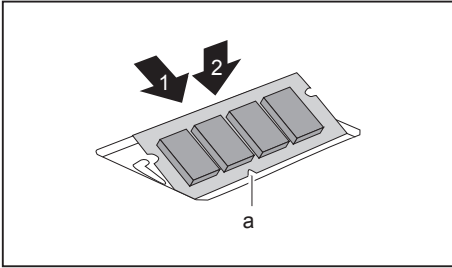

- ▶ Insert the memory module with the contacts and the recess (a) facing the slot (1).
- ▶ Carefully push the memory module downwards until you feel it click into place (2).

Securing the cover

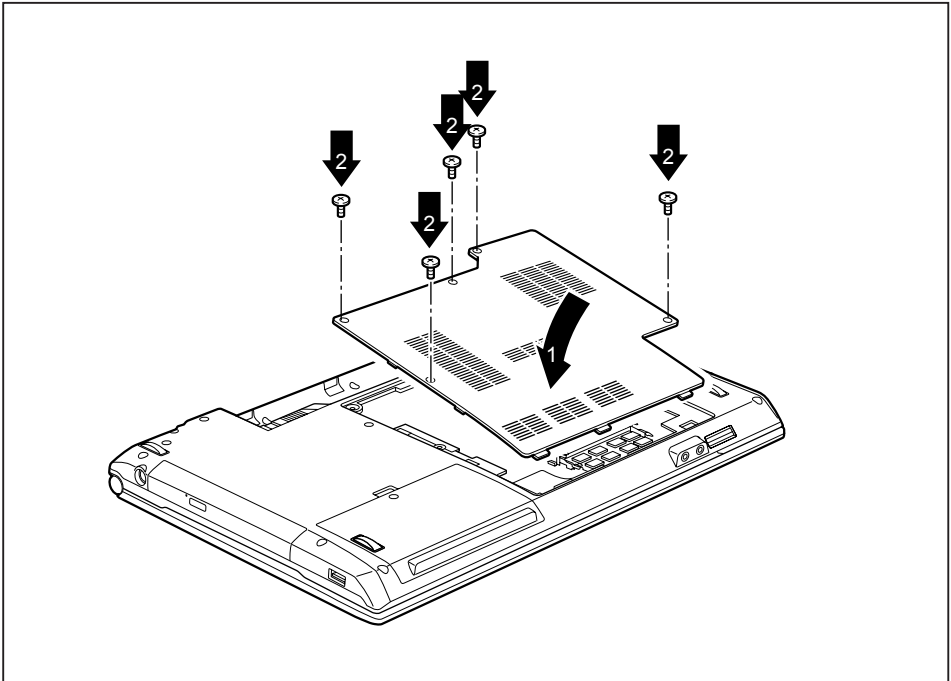

- ▶ Place the cover into its installation position in the direction of the arrow (1).
- ▶ Secure the cover with the screws (2).

Removing and installing the hard disk

Removing a cover

- ▶ Remove the battery (see Chapter ["Removing the battery", Page 31](#)).

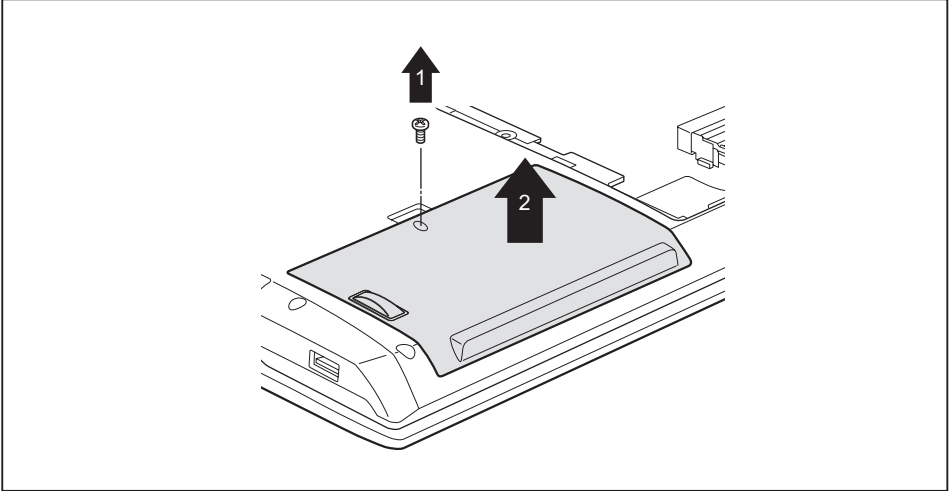

- ▶ Remove the screw (1).



Keep the screws in a safe place. If you are removing more than one component at the same time, store the screws for the individual components separately from each other. If you install the wrong screws, components may be damaged.

- ▶ Lift the cover off the notebook (2).

Removing a hard disk

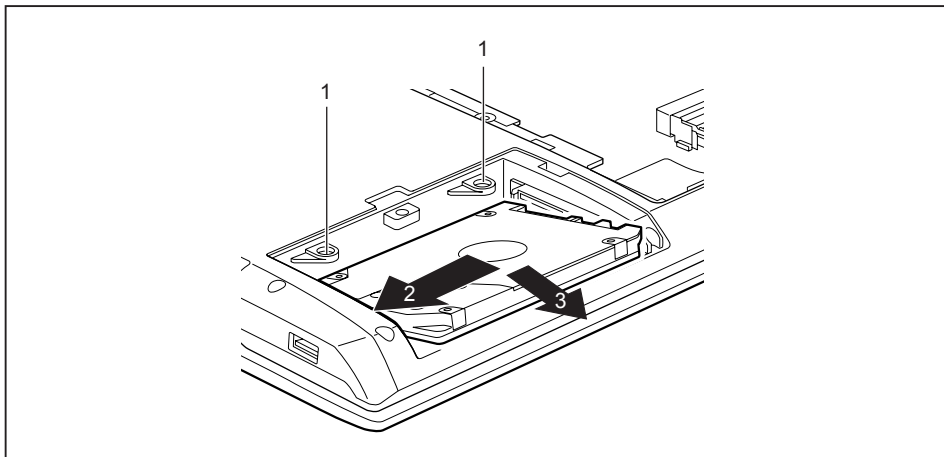

- ▶ Remove the screws (1).
- ▶ To release the hard disk from the contacts, push the hard disk in the direction of the arrow (2).
- ▶ Remove the hard disk from the hard disk compartment (3).

Installing a hard disk



If you are installing more than one component at the same time, keep the screws for the individual components separately from each other and make sure that you use the correct screws. If you install the wrong screws, components may be damaged.

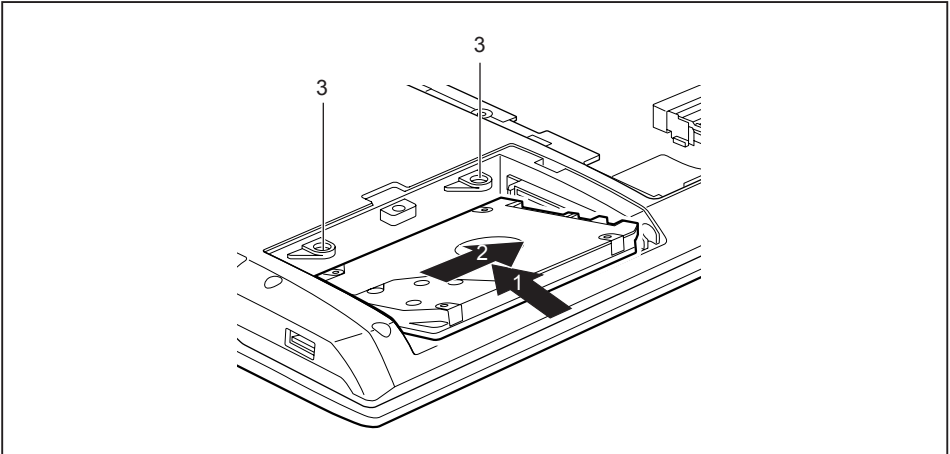

- ▶ Place the hard disk into the hard disk compartment (1).
- ▶ Slide the hard disk in the direction of the arrow (2) until it engages noticeably.
- ▶ Fasten the screws (3).

Attaching the cover

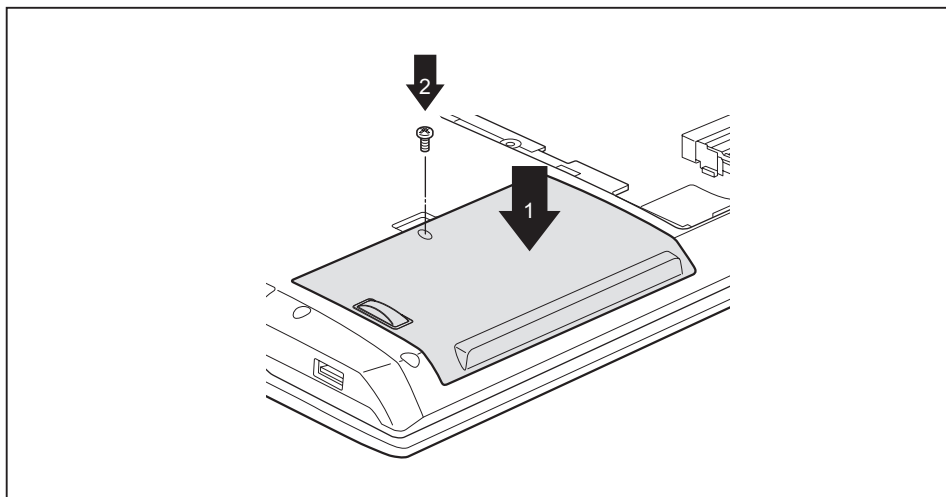

- ▶ Place the cover in the correct mounting position (1).



If you remove more than one component at the same time, keep the screws for the individual components separately from each other and make sure that you use the correct screws. If you install the wrong screws, components may be damaged.

- ▶ Fasten the screw (2).
- ▶ Insert the battery (see Chapter ["Inserting battery", Page 32](#)).

Finishing component removal

After you have removed or changed the system components as you required, please prepare your device for operation again as follows:

- ▶ Install the battery again (see ["Inserting battery", Page 32](#)).
- ▶ Turn the notebook the right way up again and place it on a flat surface.
- ▶ Reconnect the cables that you disconnected before.

Settings in BIOS Setup Utility

The *BIOS Setup Utility* allows you to set the system functions and the hardware configuration for the notebook.

When it is delivered, the notebook is set to factory default settings. You can change these settings in *BIOS Setup Utility*. Any changes you make take effect as soon as you save and exit the *BIOS Setup Utility*.

The *BIOS Setup Utility* program contains the following menus:

<i>About</i>	Displays information relating to the BIOS, processor and notebook
<i>System</i>	Advanced system settings
<i>Advanced</i>	Configuration of various hardware components, such as mouse, keyboard, processor
<i>Security</i>	Password settings and security functions
<i>Boot</i>	Configuration of the start-up sequence
<i>Exit</i>	Exits the <i>BIOS Setup Utility</i>

Starting the BIOS Setup Utility

- ▶ Reboot the device (switch off/on or reboot the operating system).
- ↳ The following or a similar display appears on the screen at start-up:

<F2> BIOS Setup <F12> Boot Menu

- ▶ Press the function key **[F2]**.
- ▶ If a password has been assigned, enter the password and press the Enter key.



If you have forgotten the password, contact your system administrator or contact our customer service centre.

The *BIOS Setup Utility* starts.

Operating BIOS Setup Utility



Press the **[F1]** key to display help on the operation of the *BIOS Setup Utility*. The description of the individual settings is shown in the right-hand window of the *BIOS Setup Utility*.

With the **[F9]** key you can load the default settings of the *BIOS Setup Utility*.

- ▶ Use the cursor keys **[←]** or **[→]** to select the menu you wish to access to make changes.
- ↳ The menu is displayed on the screen.
- ▶ Select the option you want to change with the cursor keys **[↑]** or **[↓]**.
- ▶ Press the Enter key.
- ▶ Press the **[ESC]** key to exit the selected menu.
- ▶ For future reference, make a note of the changes you have made (for example, in this manual).

Exiting BIOS Setup Utility

You need to select the desired option in the *Exit* menu and activate it by pressing the Enter key:

Exit Saving Changes - save changes and exit BIOS Setup Utility

- ▶ To save the current menu settings and exit the *BIOS Setup Utility*, select *Exit Saving Changes* and *Yes*.
- ↳ The notebook is rebooted and the new settings come into effect.

Exit Discarding Changes – Discard changes and exit BIOS Setup Utility

- ▶ To discard the changes, select *Exit Discarding Changes* and *Yes*.
- ↳ The settings in place when *BIOS Setup Utility* was called remain effective. *BIOS Setup Utility* is terminated and the notebook is rebooted.

Load Setup Defaults – Copy Standard Entries

- ▶ To copy the standard entries for all menus of the *BIOS Setup Utility*, choose *Load Setup Defaults* and *Yes*.

Discard Changes – Discard changes without exiting the BIOS Setup Utility

- ▶ To discard the changes you have made, select *Discard Changes* and *Yes*.
- ↳ The settings in place when *BIOS Setup Utility* was called remain effective. You can now make additional settings in the *BIOS Setup Utility*.
- ▶ If you want to exit *BIOS Setup Utility* with these settings, select *Exit Saving Changes* and *Yes*.

Save Changes - save changes without exiting the BIOS Setup Utility

- ▶ To save the changes, select *Save Changes* and *Yes*.
- ↳ The changes are saved. You can now make additional settings in the BIOS Setup Utility.
- ▶ If you want to exit BIOS Setup Utility with these settings, choose *Exit Saving Changes* and *Yes*.

Save Changes and Power Off

- ▶ To save the changes and switch off your device, select *Save Changes and Power Off* and *Yes*.
- ↳ The changes are saved. Your device is shut down.

Troubleshooting and tips



Follow the safety notes in the "Safety/Regulations" manual when connecting or disconnecting cables.

If a fault occurs, try to correct it as described. If you fail to correct the problem, proceed as follows:

- ▶ Make a note of the steps and the circumstances that led to the fault. Also make a note of any error messages displayed.
- ▶ Switch the notebook off.
- ▶ Please contact the Hotline/Service Desk.



You can find the telephone numbers in the service desk list. Please have the following information ready when you call:

- The model name and serial number of the notebook. The serial number is located on a sticker on the underside of the notebook.
- Notes of any messages that appear on the screen and information on acoustic signals.
- Any changes you have made to the hardware or software since receiving the notebook.
- Any changes you have made to the *BIOS Setup* settings since receiving the notebook.
- Your system configuration and all peripheral devices connected to your system.
- Your sales contract.



Our notebooks have been designed primarily with mobile applications in mind. This means that considerable effort has been made to optimise components and equipment in terms of weight, space and energy requirements. Depending on the particular configuration you have purchased, it is possible that functionality may be slightly reduced compared to a desktop PC if you are running processor-intensive gaming software, e.g. games with intensive 3D graphics. Updating your hardware with drivers which have not been approved by Fujitsu Technology Solutions may result in performance losses, data losses or malfunction of the equipment. A list of approved drivers and current BIOS versions can be downloaded from: ["http://support.ts.fujitsu.com/Download/Index.asp"](http://support.ts.fujitsu.com/Download/Index.asp)

Help if problems occur

Should you encounter a problem with your computer that you cannot resolve yourself:

- ▶ Note the ID number of your device. The ID number is found on the type rating plate on the back or underside of the casing.
- ▶ For further clarification of the problem, contact the Service Desk for your country (see the Service Desk list or visit the Internet at ["http://support.ts.fujitsu.com/contact/servicedesk/ServiceDeskNumber_Int.asp"](http://support.ts.fujitsu.com/contact/servicedesk/ServiceDeskNumber_Int.asp)). When you do this, please have ready the ID number and serial number of your system.

Restoring the hard disk contents under Windows

You can use the "Windows Recovery CD" (optionally available) and the "Drivers & Utilities CD/DVD" to reinstall the operating system.

The instructions are provided on the case of the Recovery CD.



During the reinstall process your personal files and any installed programs will be deleted. We advise you to backup your files to an external hard drive, or CD / DVD disk before you start.

- ▶ Switch the notebook on.
- ↳ The following display briefly appears on the screen during start-up:
<ESC>Diagnostic screen <F12>Boot Menu <F2>BIOS Setup
- ▶ When this message appears, press the function key **F12**.
- ▶ Insert the "Windows Recovery CD" into the optical drive.
- ▶ Select *CD-ROM* and press the Enter key.
- ▶ Follow the instructions on the screen.
 After the installation you must install all the drivers again. Some installed hardware components will not be correctly supported until this has been done.
- ▶ Insert the "Drivers & Utilities" CD/DVD into the optical drive. The CD starts automatically.
- ▶ Click on the *Desk Update* button.
- ▶ Select *Automatic driver installation (Express)* and click on *Start installation*.
- ▶ Follow the instructions on the screen.
- ▶ Restart your notebook when the driver installation is completed.

The notebook's date or time is incorrect

Cause	Troubleshooting
Time and date are incorrect.	▶ With the <i>BIOS-Setup-Utility</i> , you can set the date and time in the <i>main</i> menu.
If the time and date are still set incorrectly after switching on the notebook.	▶ Please contact your sales outlet or our Hotline/Service Desk.

The notebook's LCD screen remains blank

Cause	Troubleshooting
Monitor is switched off.	▶ Press a key or touch the touchpad.
External monitor or television set connected.	▶ Press the key combination to switch the screen output, see "Key combinations", Page 24 .

The LCD screen is difficult to read

Cause	Troubleshooting
Reflected glare	<ul style="list-style-type: none"> ▶ Turn the notebook or alter the tilt of the LCD screen. ▶ Increase the brightness of the screen.

The external monitor remains blank

Cause	Troubleshooting
Monitor is switched off.	▶ Switch the external monitor on.
Power saving has been activated (monitor is blank).	▶ Press any key to continue.
Brightness is set to dark.	▶ Adjust the brightness of the monitor.
Screen output is set to the notebook's LCD screen	▶ Press the key combination to switch the screen output, see " Key combinations ", Page 24 .
The external monitor's power cable or data cable is not connected properly.	<ul style="list-style-type: none"> ▶ Switch off the external monitor and the notebook. ▶ Check whether the power cable is plugged properly into the external monitor and into the power socket. ▶ Check whether the data cable is properly connected to the notebook and the external monitor (if it is plugged in with a connector). ▶ Switch on the external monitor and the notebook.

The external monitor is blank or the image is unstable

Cause	Troubleshooting
The wrong external monitor has been selected or the wrong screen resolution has been set for the application program.	<ul style="list-style-type: none"> ▶ Terminate the application program in Windows by pressing <code>[Alt] + [F4]</code>. If the fault persists after closing the program, use the key combination for switching the screen output (see "Key combinations", Page 24) to switch over to the notebook's LCD screen. Change the following setting: <ul style="list-style-type: none"> ▶ Set the screen resolution: Set the screen resolution as described in the documentation for your operating system. ▶ Select monitor: Select monitor 1 or 2 as described in the documentation for your operating system.

The notebook cannot be started

Cause	Troubleshooting
The battery is not installed correctly.	<ul style="list-style-type: none"> ▶ Check whether the battery is installed correctly in its compartment. ▶ Switch the notebook on.
The battery is dead.	<ul style="list-style-type: none"> ▶ Charge the battery. <p>or</p> <ul style="list-style-type: none"> ▶ Insert a charged battery. <p>or</p> <ul style="list-style-type: none"> ▶ Connect the mains adapter to the notebook.
The power adapter is not connected correctly.	<ul style="list-style-type: none"> ▶ Check whether the mains adapter is connected correctly to the notebook. ▶ Switch the notebook on.

The notebook stops working

Cause	Troubleshooting
Notebook is in energy saving mode.	<ul style="list-style-type: none"> ▶ Leave energy saving mode.
An application programme has caused the malfunction.	<ul style="list-style-type: none"> ▶ Close the application program or restart the notebook (by restarting the operating system or switching the device off and back on again).
The battery is dead.	<ul style="list-style-type: none"> ▶ Charge the battery. <p>or</p> <ul style="list-style-type: none"> ▶ Insert a charged battery. <p>or</p> <ul style="list-style-type: none"> ▶ Connect the mains adapter to the notebook.

The printer does not print

Cause	Troubleshooting
The printer is not switched on.	<ul style="list-style-type: none"> ▶ Make sure that the printer is switched on and ready for operation (refer to the documentation supplied with the printer).
The printer is not connected correctly.	<ul style="list-style-type: none"> ▶ Check that the data cable connecting the notebook to the printer is properly connected.
The printer driver is faulty or not correctly installed, or it is the wrong printer driver.	<ul style="list-style-type: none"> ▶ Check that the data cable connecting the notebook to the printer is properly connected. ▶ Check whether the correct printer driver is loaded (refer to the printer documentation).

The radio connection to a network does not work

Cause	Troubleshooting
The wireless component is disabled.	<ul style="list-style-type: none"> ▶ Switch the radio component on (see "Switching the wireless components on and off", Page 40).
The wireless component is enabled. Despite this, the wireless connection to a network does not work.	<ul style="list-style-type: none"> ▶ Check whether the radio connection is switched on via the software. ▶ Further information on using the radio component can be found in the help files.

Acoustic warnings

Cause	Troubleshooting
A beep sounds every few seconds. The battery is almost flat.	<ul style="list-style-type: none"> ▶ Charge the battery.

Error messages on the screen

This section describes the error messages generated by the BIOS Setup. Error messages displayed by the operating system or programmes are described in the relevant documentation.



If the error message appears repeatedly, despite troubleshooting measures, please contact the place of purchase or our customer service centre.

Error message/cause	Resolution
<p><i>CMOS battery bad</i></p> <p>If the error message occurs repeatedly, the buffer battery in the notebook is flat.</p>	<ul style="list-style-type: none"> ▶ Contact your sales outlet or our customer service centre.
<p><i>System CMOS checksum bad - default configuration used</i></p> <p>The system configuration information is incorrect.</p>	<ul style="list-style-type: none"> ▶ Switch the notebook off. ▶ Switch the notebook on. ▶ Press the function key [F2] to access the <i>BIOS Setup</i>. ▶ In the <i>BIOS Setup</i>, select the <i>Exit</i> menu. ▶ Select the entry <i>Load Setup Defaults</i>. ▶ Select <i>OK</i> and press the Enter key.
<p><i>Extended memory failed at offset: xxxx Failing Bits: zzzz zzzz</i></p> <p>When testing the extended memory an error has resulted at the address xxxx.</p>	<ul style="list-style-type: none"> ▶ Check whether the additional memory module has been inserted correctly.
<p><i>Failure Fixed Disk n</i></p> <p>The settings of the hard disk drive are incorrect.</p>	<ul style="list-style-type: none"> ▶ Start the <i>BIOS Setup (Primary Master submenu)</i> and select the correct settings.
<p><i>Keyboard controller error</i></p>	<ul style="list-style-type: none"> ▶ Switch the notebook off with the ON/OFF switch. ▶ Wait 3 - 5 seconds and switch on the notebook again.
<p><i>Keyboard error</i></p>	<p>If you are using an external keyboard:</p> <ul style="list-style-type: none"> ▶ Check the connection and reboot the notebook.
<p><i>nn Stuck key</i></p>	<ul style="list-style-type: none"> ▶ Make sure that no key is pressed.
<p><i>Operating system not found</i></p>	<ul style="list-style-type: none"> ▶ Check in the <i>BIOS Setup</i> whether your hard disk has been set correctly. ▶ Make sure that the operating system is installed on the corresponding drive.
<p><i>Press <F1> to resume, <F2> to SETUP</i></p> <p>This error message appears if an error occurs during the self-test before starting the operating system.</p>	<ul style="list-style-type: none"> ▶ Press the [F1] function key to start the operating system. ▶ Press the function key [F2] to access the <i>BIOS Setup</i>.
<p><i>Previous boot incomplete - Default configuration used</i> Due to an error during the previous system boot, default values were used for certain settings. Check the settings in the BIOS Setup.</p>	<ul style="list-style-type: none"> ▶ Press the [F1] function key when prompted to do so.
<p><i>Real time clock error</i></p>	<ul style="list-style-type: none"> ▶ Contact your sales outlet or our customer service centre.
<p><i>nnnnK Shadow RAM failed at offset: xxxx Failing Bits: zzzz</i></p>	<ul style="list-style-type: none"> ▶ Contact your sales outlet or our customer service centre.
<p><i>System battery is dead - Replace and run SETUP</i></p>	<ul style="list-style-type: none"> ▶ Contact your sales outlet or our customer service centre.

Error message/cause	Resolution
<i>System cache error - Cache disabled</i>	▶ Contact your sales outlet or our customer service centre.
<i>System timer error</i>	▶ Contact your sales outlet or our customer service centre.

Technical data

LIFEBOOK

Ambient conditions	
Temperature:	
Operation	5 °C ... 35 °C
Transportation	-15 °C ... 60 °C
Dimensions	
Width x depth x height (front/back)	378 mm x 252 mm x 29.2 mm / 34.2 mm (33.2 mm without rubber feet)
Weight (including 6-cell rechargeable battery)	Approx. 2.5 kg



The data sheet for the device provides further technical data. You will find the data sheet on your device or on the Internet at "<http://www.fujitsu.com/fts/support/>".

Rechargeable battery



You can find information on the batteries used in your device on the Internet at "<http://www.fujitsu.com/fts/support/>".

	6-cell rechargeable battery
Rated voltage	10.8 V
Rated capacity	4400 mAh (48 Wh)

Mains adapter 80W

Primary

Rated voltage	100 V to 240 V (automatic)
Rated frequency	50 Hz to 60 Hz (automatic)

Secondary

Rated voltage	19 V
Max. rated current	4.22 A

An additional mains adapter or power cable can be ordered at any time.

Power adapter, 65 W

Primary

Rated voltage	100 V to 240 V (automatic)
Rated frequency	50 Hz to 60 Hz (automatic)

Secondary (device-dependent)

Rated voltage	19 V
Max. rated current	3.42 A

Secondary (device-dependent)

Rated voltage	20 V
Max. rated current	3.25 A

An additional mains adapter or power cable can be ordered at any time.

Manufacturer's notes

Disposal and recycling

You can find information on this subject on your notebook or on our website (["http://www.fujitsu.com/fts/about/fts/environment-care/"](http://www.fujitsu.com/fts/about/fts/environment-care/)).

Declarations of Conformity

The "Declarations of Conformity" for the device can be found on the Internet at: ["http://globalsp.ts.fujitsu.com/sites/certificates/default.aspx"](http://globalsp.ts.fujitsu.com/sites/certificates/default.aspx).

Fujitsu Technology Solutions hereby declares that your device is in compliance with the essential requirements and other relevant provisions of Directive 1999/5/EC.

CE marking

CE marking for devices with radio component

This device, in the version delivered, complies with the requirements of Directive 2009/125/EC on "Ecodesign" as well as the requirements of R&TTE Directive 199/5/EC of the European Parliament and Council dated 9 March 1999 governing radio and telecommunications terminal equipment and mutual recognition of conformity.

This equipment can be used in the following countries:

Belgium	Bulgaria	Denmark	Germany
Estonia	Finland	France	Greece
UK	Ireland	Iceland	Italy
Latvia	Liechtenstein	Lithuania	Luxembourg
Malta	The Netherlands	Norway	Austria
Poland	Portugal	Rumania	Sweden
Switzerland	Slovakia	Slovenia	Spain
Czech Republic	Hungary	Cyprus	

Contact the corresponding government office in the respective country for current information on possible operating restrictions. If your country is not included in the list, then please contact the corresponding supervisory authority as to whether the use of this product is permitted in your country.

Regulatory notices



If there is no FCC logo and also no FCC ID on the device then this device is not approved by the Federal Communications Commission (FCC) of the USA. Although it is not explicitly forbidden to travel in the US trading area carrying this device, to avoid trouble at customs clearance, Fujitsu Technology Solutions GmbH recommends not to bring this device into the US trading area.

Regulatory information for notebooks without radio device

NOTICE:

Changes or modifications not expressly approved by Fujitsu Technology Solutions could void this user's authority to operate the equipment.

Notice to Users of Radios and Television

These limits are designed to provide reasonable protection against harmful interference in a residential installation. This equipment generates, uses, and can radiate radio frequency energy and, if not installed and used in accordance with the instructions, may cause harmful interference to radio communications. However, there is no guarantee that interference will not occur in a particular installation. If this equipment does cause harmful interference to radio or television reception, which can be determined by turning the equipment off and on, the user is encouraged to try to correct the interference by one or more of the following measures:

- Reorient or relocate the receiving antenna.
- Increase the separation between the equipment and receiver.
- Connect the equipment into an outlet that is on a different circuit than the receiver.
- Consult the dealer or an experienced radio/TV technician for help.

Notice to Users of the US Telephone Network

Your notebook may be supplied with an internal modem which complies with Part 68 of the FCC rules. On this notebook is a label that contains the FCC Registration Number and the Ringer Equivalence Number (REN) for this equipment among other information. If requested, the user must provide their telephone company with the following information:

1. The telephone number to which the notebook is connected.
2. The Ringer Equivalence Number (REN) for this equipment.
3. The equipment requires a standard modular jack type USOC RJ-11C which is FCC Part 68 compliant.
4. The FCC Registration Number.

This equipment is designed to be connected to the telephone network or premises wiring using a standard modular jack type USOC RJ-11C which is FCC Part 68 compliant and a line cord between the modem and the telephone network with a minimum of 26AWG.

The REN is used to determine the number of devices that you may connect to your telephone line and still have all of those devices ring when your number is called. Too many devices on one line may result in failure to ring in response to an incoming call. In most, but not all, areas the sum of the RENs of all of the devices should not exceed five (5). To be certain of the number of devices you may connect to your line, as determined by the RENs, contact your local telephone company. If this equipment causes harm to the telephone network, your telephone company may discontinue your service temporarily. If possible, they will notify you in advance. If advance notice is not practical they will notify you as soon as possible. You will also be advised of your right to file a complaint with the FCC.

This fax modem also complies with fax branding requirements per FCC Part 68.

Your telephone company will probably ask you to disconnect this equipment from the telephone network until the problem is corrected and you are sure that the equipment is not malfunctioning. This equipment may not be used on coin-operated telephones provided by your telephone company. Connection to party lines is subject to state tariffs. Contact your state's public utility commission, public service commission or corporation commission for more information.

This equipment includes automatic dialing capability. When programming and/or making test calls to emergency numbers:

- Remain on the line and briefly explain to the dispatcher the reason for the call.
- Perform such activities in off-peak hours, such as early morning or late evening.

FCC rules prohibit the use of non-hearing aid compatible telephones in the following locations or applications:

- All public or semi-public coin-operated or credit card telephones.
- Elevators, highways, tunnels (automobile, subway, railroad or pedestrian) where a person with impaired hearing might be isolated in an emergency.
- Places where telephones are specifically installed to alert emergency authorities such as fire, police or medical assistance personnel.
- Hospital rooms, residential health care facilities, convalescent homes and prisons.
- Hotel, motel or apartment lobbies.
- Stores where telephones are used by patrons to order merchandise.
- Public transportation terminals where telephones are used to call taxis or to reserve lodging or rental cars.
- In hotel and motel rooms as at least ten percent of the rooms must contain hearing aid-compatible telephones or jacks for plug-in hearing aid compatible telephones which will be provided to hearing impaired customers on request.

DOC (Industry CANADA) notices

Notice to Users of Radios and Television

This Class B digital apparatus meets all requirements of Canadian Interference-Causing Equipment Regulations.

CET appareil numérique de la class B respecte toutes les exigence du Règlement sur le matériel brouilleur du Canada.

Notice to Users of the Canadian Telephone Network

NOTICE:

This equipment meets the applicable Industry Canada Terminal Equipment Technical Specifications. This is confirmed by the registration number. The abbreviation, IC, before the registration number signifies that registration was performed based on a Declaration of Conformity indicating that Industry Canada technical specifications were met. It does not imply that Industry Canada approved the equipment. Before connecting this equipment to a telephone line the user should ensure that it is permissible to connect this equipment to the local telecommunication facilities. The user should be aware that compliance with the certification standards does not prevent service degradation in some situations.

Repairs to telecommunication equipment should be made by a Canadian authorised maintenance facility. Any repairs or alterations not expressly approved by Fujitsu or any equipment failures may give the telecommunication company cause to request the user to disconnect the equipment from the telephone line.

NOTICE:

The Ringer Equivalence Number (REN) for this terminal equipment is 0.0. The REN assigned to each terminal equipment provides an indication of the maximum number of terminals allowed to be connected to a telephone interface. The termination on an interface may

consist of any combination of devices subject only to the requirement that the sum of the Ringer Equivalence Numbers of all the devices does not exceed five.



CAUTION:

For safety, users should ensure that the electrical ground of the power utility, the telephone lines and the metallic water pipes are connected together. Users should NOT attempt to make such connections themselves but should contact the appropriate electric inspection authority or electrician. This may be particularly important in rural areas.

Avis Aux Utilisateurs Du Réseau Téléphonique Canadien

AVIS : Le présent matériel est conforme aux spécifications techniques d'Industrie Canada applicables au matériel terminal. Cette conformité est confirmée par le numéro d'enregistrement. Le sigle IC, placé devant le numéro d'enregistrement, signifie que l'enregistrement s'est effectué conformément à une déclaration de conformité et indique que les spécifications techniques d'Industrie Canada ont été respectées. Il n'implique pas qu'Industrie Canada a approuvé le matériel.

Avant de connecter cet équipement à une ligne téléphonique, l'utilisateur doit vérifier s'il est permis de connecter cet équipement aux installations de télécommunications locales. L'utilisateur est averti que même la conformité aux normes de certification ne peut dans certains cas empêcher la dégradation du service.

Les réparations de l'équipement de télécommunications doivent être effectuées par un service de maintenance agréé au Canada. Toute réparation ou modification, qui n'est pas expressément approuvée par Fujitsu, ou toute défaillance de l'équipement peut entraîner la compagnie de télécommunications à exiger que l'utilisateur déconnecte l'équipement de la ligne téléphonique.

AVIS : L'indice d'équivalence de la sonnerie (IES) du présent matériel est de 0.0. L'IES assigné à chaque dispositif terminal indique le nombre maximal de terminaux qui peuvent être raccordés à une interface téléphonique. La terminaison d'une interface peut consister en une combinaison quelconque de dispositifs, à la seule condition que la somme d'indices d'équivalence de la sonnerie de tous les dispositifs n'excède pas 5.



AVERTISSEMENT:

Pour assurer la sécurité, les utilisateurs doivent vérifier que la prise de terre du service d'électricité, les lignes téléphoniques et les conduites d'eau métalliques sont connectées ensemble. Les utilisateurs NE doivent PAS tenter d'établir ces connexions eux-mêmes, mais doivent contacter les services d'inspection d'installations électriques appropriés ou un électricien. Ceci peut être particulièrement important en régions rurales.

UL Notice

This unit requires an AC adapter to operate. Only use a UL Listed Class 2 adapter. The correct output rating is indicated on the AC adapter label. Refer to the illustration below for the correct AC Adapter output polarity:



CAUTION:

To reduce the risk of fire, use only 26AWG or larger telecommunications line cord.

For Authorized Repair Technicians Only



CAUTION:

For continued protection against risk of fire, replace only with the same type and rating fuse.



WARNING:

Danger of explosion if Lithium (CMOS) battery is incorrectly replaced. Replace only with the same or equivalent type recommended by the manufacturer.

Dispose of used batteries according to the manufacturer's instructions.

FCC regulatory information for notebooks with radio device

Federal Communications Commission statement

This device complies with Part 15 of FCC Rules. Operation is subject to the following two conditions: (1) this device may not cause interference, and

(2) this device must accept any interference, including interference that may cause undesired operation of this device.

FCC Interference Statement

This equipment has been tested and found to comply with the limits for a Class B digital device, pursuant to Part 15 of the FCC Rules. These limits are designed to provide reasonable protection against harmful interference in a residential installation. This equipment generates, uses, and can radiate radio frequency energy. If not installed and used in accordance with the instructions, it may cause harmful interference to radio communications.

However, there is no guarantee that interference will not occur in a particular installation.

If this equipment does cause harmful interference to radio or television reception, which can be determined by turning the equipment off and on, the user is encouraged to try to correct the interference by one or more of the following measures:

1. Reorient or relocate the receiving antenna.
2. Increase the distance between the equipment and the receiver.
3. Connect the equipment to an outlet on a circuit different from the one the receiver is connected to.
4. Consult the dealer or an experienced radio/TV technician for help.

Please note the following regulatory information related to the optional radio device.

FCC Radio Frequency Exposure statement

This radio device has been evaluated under FCC Bulletin OET 65C and found compliant with the requirements as set forth in CFR 47 Sections 2.1091, 2.1093, and 15.247 (b) (4) addressing RF Exposure from radio frequency devices. The radiated output power of this radio device is far below the FCC radio frequency exposure limits. Nevertheless, this device shall be used in such a manner that the potential for human contact during normal operation is minimized. When using this device, a certain separation distance between antenna and nearby persons must be maintained to ensure RF exposure compliance. In order to comply with RF exposure limits established in the ANSI C95.1 standards, the distance between the antennas and the user should not be less than 20 cm (8 inches).

Regulatory Notes and Statements

Radio device, health and authorisation for use

Radio-frequency electromagnetic energy is emitted from the wireless devices. The energy levels of these emissions, however, are far much less than the electromagnetic energy emissions from wireless devices such as mobile phones. Radio devices are safe for use by consumers because they operate within the guidelines found in radio frequency safety standards and recommendations.

The use of the radio devices may be restricted in some situations or environments, such as:

- on board an airplane, or
- in an explosive environment, or
- in situations where the interference risk to other devices or services is perceived or identified as harmful.

In cases in which the policy regarding use of radio devices in specific environments is not clear (e.g., airports, hospitals, chemical/oil/gas industrial plants, private buildings), obtain authorization to use these devices prior to operating the equipment.

Regulatory Information/Disclaimers

Installation and use of this radio device must be in strict accordance with the instructions included in the user documentation provided with the product. Any changes or modifications made to this device that are not expressly approved by the manufacturer may void the user's authority to operate the equipment. The manufacturer is not responsible for any radio or television interference caused by unauthorized modification of this device, or the substitution or attachment of connecting cables and equipment other than those specified by the manufacturer. It is the responsibility of the user to correct any interference caused by such unauthorized modification, substitution or attachment. The manufacturer and its authorized resellers or distributors will assume no liability for any damage or violation of government regulations arising from failure to comply with these guidelines.

Export restrictions

This product or software contains encryption code which may not be exported or transferred from the US or Canada without an approved US Department of Commerce export license. This device complies with Part 15 of FCC Rules, as well as ICES 003 B / NMB 003 B. Operation is subject to the following two conditions:

- (1) this device may not cause harmful interference, and
- (2) this device must accept any interference received, including interference that may cause undesirable operation.

Modifications not expressly authorised by Fujitsu Technology Solutions may invalidate the user's right to operate this equipment.

Index

- A**
Acoustic error messages 65
Alt + Tab 25
Anti-theft protection 42
Audio devices, connecting 50
Audio ports 50
- B**
Back tab 25
Backspace 23
Bass loudspeaker (subwoofer) 38
Battery
 battery life 30
 caring for and maintaining 30
 charge level 30, 35
 charging 30
 self-discharge 30
 storage 30
Battery indicator 20
Battery status indicator
 see Battery indicator 20
Battery status meter 30
Battery symbol
 see Battery indicator 20
BIOS Setup Utility
 calling 59
 exiting 60
 operating 59
 protecting with password 43
 settings 59
Bluetooth
 Switching the module off 40
 Switching the module on 40
Bluetooth, safety notes 13
Board 51
Buffer battery, load 62
Buttons 22
- C**
Caps Lock 23
 indicator 20
CD/DVD indicator 33
CD/DVD:
 manual emergency removal 34
CE marking 70
Charging capacity, battery 30
Cleaning 15
Components
 installing / removing 51
Configuration, BIOS Setup Utility 59
Connecting audio devices 50
Connecting headphones 50
Crystal View display
 cleaning 15
Cursor control keys 23
Cursor keys 23
- D**
Date is incorrect 62
Declaration of conformity 70
Device
 setting up 17
Devices
 connecting 46
 disconnecting 46
DOC (INDUSTRY CANADA) NOTICES 72
Drive
 indicator 20
- E**
Emergency removal of data carrier 34
Energy
 energy saving 14
Energy saving 14
Energy saving functions 25
Energy saving mode
 leaving 64
Enter 23
Enter key 23
Error message:
 on the screen 65
Error messages on the screen 65
Errors
 Acoustic warnings 65
ESD 51
Ethernet LAN 41
ExpressCard 37
- F**
Fault
 correction 61
First-time setup 16
Fn key 23
Fn+F10 25
Fn+F11 25
Fn+F12 25
Fn+F3 24
Fn+F4 24
Fn+F5 24

Fn+F6 25
Fn+F7 25
Fn+F8 25
Fn+F9 25

G

Getting started 16

H

Handling
 data carriers 32
Hard disk:
 restoring the contents 62
Hardware configuration 59
HDMI port 47

I

Important notes 13
Incorrect date/time 62
Indicator
 Caps Lock 20
 drive 20
 Num Lock 20
Inserting
 a data carrier 33

K

Key combinations 24
Keyboard 22
 cleaning 15

L

LCD screen
 cleaning 15
 decrease brightness 25
 difficult to read 63
 notes 28
 reflected glare 63
 remains blank 62
LCD screen is too dark 62
Life, battery 30
Line feed 23
Loudspeakers 38
 switch off 24
 switch on 24

M

Main memory

 see Adding memory 52
Mains adapter
 connecting 17
 setting up 17
Manual removal of data carrier 34
Mechanical backup 42
Memory card
 handling 36
 inserting 36
 removing 36
Memory expansion
 installing 54
 removing 53
Memory module
 important notes 52
 installing 54
 removing 53
Microphone 38
Microphone, connecting 50
Mobile operation 14
Monitor
 connecting 47
 drifting display 63
 remains blank 63
Monitor port
 see VGA connection socket 47

N

Notebook
 before you travel 14
 cannot be started 64
 cleaning 15
 stops working 64
 switching off 21
 transporting 14–15
 using 19
Notebook, operation 19
Notes 13
 boards 51
 cleaning 15
 disposal / recycling 70
 energy saving 14
 LCD screen 28
 Safety 13
 transport 14
Num Lock
 indicator 20, 24
Numeric keypad 22
 see Separate numeric keypad 24

- O**
- Operating system
 - activating system protection 44
 - cancel system protection 44
 - protecting with password 44
- Operating system, restoring 62
- Optical drive 32

- P**
- Packaging 16
- Password
 - changing 44
 - entering 43
 - removing 44
- Password protection 43
- Password protection:
 - hard disk 45
- Peripheral devices
 - connecting 46
 - disconnecting 46
- Power
 - power consumption 35
 - power-management features 35
- Power indicator 20
- Preparing for operation 17
- Printer does not print 65

- R**
- Radio component:
 - safety notes 13
- Rechargeable battery 30
 - see Battery 30
- Regulatory information
 - notebooks with radio device 74
 - Notebooks without radio device 71
- Removing
 - a data carrier 33
- Removing memory
 - see Adding memory 52
- Return 23

- S**
- Safety notes 13
- Screen
 - no screen display 63
- Screen brightness
 - decrease 25
 - increase 25
- Screen port
 - see VGA connection socket 47
- Security functions 42
- Security Lock 42

- Selecting a location 17
- Self-discharge, battery 30
- Separate numeric keypad 24
- Servicing 51
- Setup
 - see BIOS Setup Utility 59
- Shift 23
- Shift + Tab 25
- Shift key 23
- Slot
 - ExpressCard 37
 - Memory cards 36
- Standby indicator 20
- Status indicators 19
- Strg+Alt+Entf / Ctrl+Alt+Del 25
- Summer time 62
- Supervisor password
 - changing 44
 - entering 43
 - removing 44
- Switching on
 - the notebook 21
- Switching on for the first time 18
- System configuration 59
- System expansion 52
 - see Adding memory 52
- System settings, BIOS Setup Utility 59

- T**
- Tab key 23
- Technical data 68
 - Mains adapter 68–69
 - notebook 68
- The radio connection to a network does not work 65
- Time not correct 62
- Time, daylight savings 62
- Tips 61
- Toggle output screen 25
- Touchpad 24, 26
 - buttons 26
 - cleaning 15
 - dragging items 27
 - executing commands 27
 - moving the pointer 26
 - selecting an item 27
 - switch off 24
- Touchpad buttons 24
- Transport
 - Transport damage 16
- Transportation 14–15
- Travel, notebook 14
- Troubleshooting 61

U

- USB charging function 49
- USB ports 48
- User password
 - changing 44
 - entering 43
 - removing 44
- Using the Kensington Lock Cable 42

V

- VGA connection socket 47
- Volume
 - decrease 25
 - increase 25
- Volume control 38

W

- Webcam 29
 - off 25
- Windows key 23
- Wireless components
 - switch off 24
 - switch on 24
- Wireless LAN
 - Switching the module off 40
 - Switching the module on 40
- Wireless LAN:
 - safety notes 13